

Analog CPU Module Specifications

C0-02DR-D <--->

4 DC Input/4 Relay Output; 2 Analog In/2 Analog Out Micro PLC

CLICK PLC CPU, 4 DC in / 4 relay out, 2-Ch Analog In / 2-Ch Analog out (current/voltage selectable), requires a 24 VDC power supply, 8K steps program memory, Ladder Logic programming, built-in RS232C programming port and RS232C Modbus/ASCII communications port (configurable up to 115.2K baud) and 3-wire RS485 Modbus/ASCII communications port. Real Time Clock/Calendar and battery backed memory. Discrete Inputs: 4 DC inputs, 24 VDC sink/source, 1 common. Discrete Outputs: 4 relay outputs, 6-240 VAC / 6-27 VDC Form A (SPST) relays, 1.0A/point, 1 common. Analog Inputs: 2 channels, 4-20 mA, 0-5 VDC. Analog Outputs: 2 channels, 4-20 mA, 0-5 VDC. Removable terminal block included.

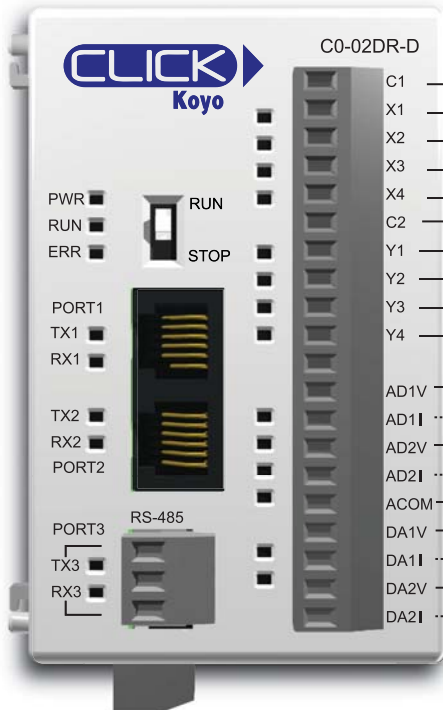

Wiring Diagram

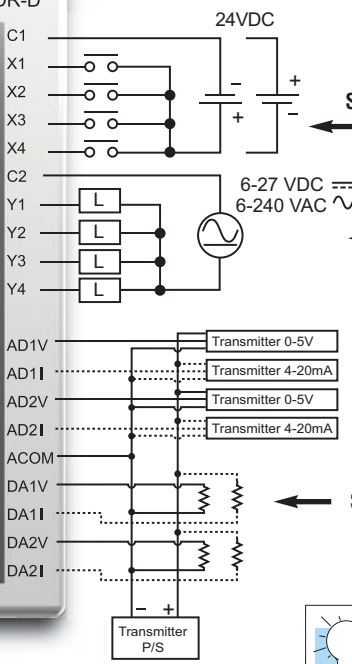

General Specifications	
Current Consumption at 24VDC	120 mA
Terminal Block Replacement Part No.	C0-16TB
Weight	5.6 oz (160 g)

Typical Relay Life (Operations) at Room Temperature	
Voltage & Load Type	Load Current: 1 A
30 VDC Resistive	300,000 cycles
30 VDC Solenoid	50,000 cycles
120 VAC Resistive	500,000 cycles
120 VAC Solenoid	200,000 cycles
ON to OFF = 1 cycle	

See Discrete I/O Specifications - Inputs (X1 through X4)

See Discrete I/O Specifications - Outputs (Y1 through Y4)

See Analog Specifications - Voltage & Current Input (AD1V through AD2I)

See Analog Specifications - Voltage & Current Output (DA1V through DA2I)



NOTE: WHEN USING ANALOG CPUs, YOU MUST ALSO USE CLICK PROGRAMMING SOFTWARE VERSION V1.10 OR LATER.



IMPORTANT: YOU CAN USE ONLY ONE TERMINAL (VOLTAGE OR CURRENT) PER CHANNEL. YOU MUST ALSO SELECT THE ANALOG TYPE (VOLTAGE OR CURRENT) IN THE CPU BUILT-IN I/O SETUP IN THE CLICK PROGRAMMING SOFTWARE (PULL-DOWN MENU SETUP > CPU BUILT-IN I/O SETUP).

X1 - X4

C0-02DR-D Discrete I/O Specifications - Inputs	
Inputs per Module	4 (Source/Sink)
Operating Voltage Range	24 VDC
Input Voltage Range	21.6 - 26.4 VDC
Input Current	X1-2: Typ 5 mA @ 24 VDC X3-4: Typ 4 mA @ 24 VDC
Input Impedance	X1-2: 4.7 kΩ @ 24 VDC X3-4: 6.8 kΩ @ 24 VDC
ON Voltage Level	X1-2: > 19 VDC X3-4: > 19 VDC
OFF Voltage Level	X1-2: < 4 VDC X3-4: < 7 VDC
Minimum ON Current	X1-2: 4.5 mA X3-4: 3.5 mA
Maximum OFF Current	X1-2: 0.1 mA X3-4: 0.5 mA
OFF to ON Response	X1-2: Typ 5 μs Max 20 μs* X3-4: Typ 2 ms Max 10 ms
ON to OFF Response	X1-2: Typ 5 μs Max 20 μs* X3-4: Typ 3 ms Max 10 ms
Status Indicators	Logic Side (4 points, green LED)
Commons	1 (4 points/common)

Equivalent Discrete Input Circuit

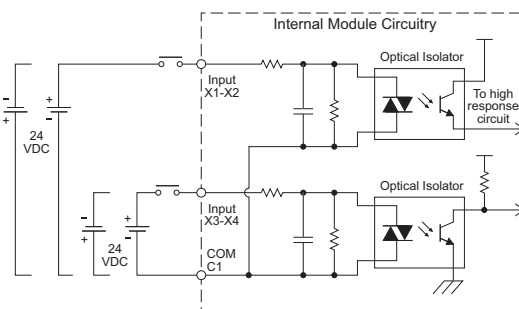

C0-02DR-D Temperature Derating Chart

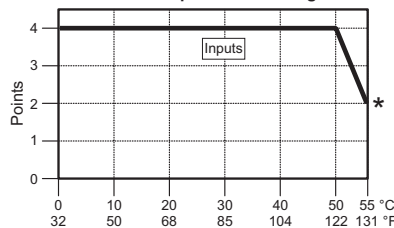

There are no ZipLink pre-wired PLC connection cables and modules for the analog CPUs. (Cannot mix discrete I/O and analog I/O signals in a ZIPLink cable.)

* Threshold level is 70% amplitude.

* Use every other input.

Analog CPU Module Specifications

C0-02DR-D (cont'd)

Y1 - Y4

C0-02DR-D Discrete I/O Specifications - Outputs	
Outputs per Module	4
Operating Voltage Range	6-27 VDC6 (-15%/+10%)/ 6-240 VAC (-10%/+10%)
Output Type	Relay, form A (SPST)
AC Frequency	47-63 Hz
Maximum Current	1 A/point (resistive)
Minimum Load Current	5 mA @ 5 VDC
Maximum Inrush Current	3 A for 10 ms
OFF to ON Response	< 15 ms
ON to OFF Response	< 15 ms
Status Indicators	Logic Side (4 points, red LED)
Commons per Module	1 (4 points/common)
Fuse	None

AD1V - AD2I

C0-02DR-D Analog Specifications - Voltage Input	
Number of Channels	2 (voltage/current selectable)
Input Range	0 - 5 VDC
Resolution	12 bit
Conversion Time	50 ms
Input Impedance	150 kΩ
Input Stability	±2 LSB maximum
Full-Scale Calibration Error	±1.2% maximum
Offset Calibration Error	±5 mV maximum
Accuracy vs. Temperature Error	±100 ppm / °C maximum

Analog Voltage Input Circuit

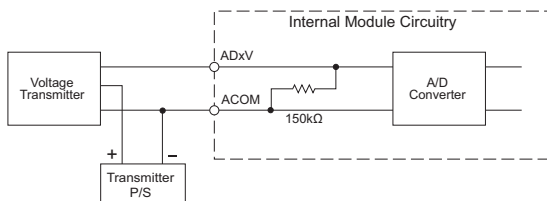

DA1V - DA2I

C0-02DR-D Analog Specifications - Voltage Output	
Outputs per Module	2 (voltage/current selectable)
Output Range	0 - 5 VDC
Resolution	12 bit
Conversion Time	1 ms
Load Impedance	2 kΩ minimum (output current 2.5 mA maximum)
Full-Scale Calibration Error	±0.8% maximum
Offset Calibration Error	±5 mV maximum
Accuracy vs. Temperature Error	±100 ppm / °C maximum

Analog Voltage Output Circuit

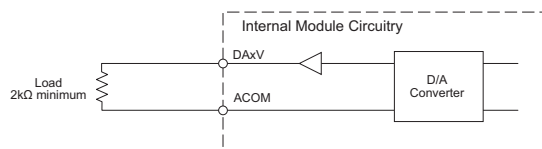

Equivalent Output Circuit

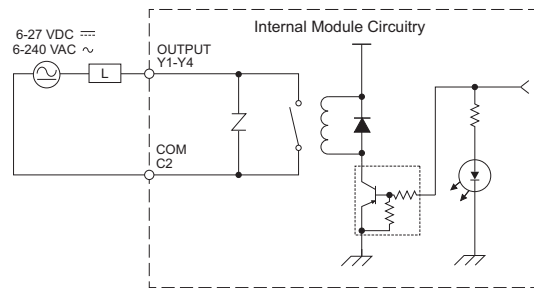

This circuit does not contain built-in protection.
Install protection elements such as a fuse outside the module if necessary.

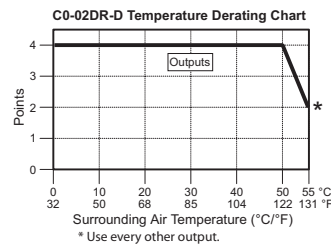

C0-02DR-D Analog Specifications - Current Input	
Inputs per Module	2 (voltage/current selectable)
Input Range	4 - 20 mA
Resolution	12 bit
Conversion Time	50 ms
Input Impedance	200 Ω
Input Stability	±2 LSB
Full-Scale Calibration Error	±1% maximum
Offset Calibration Error	±0.1 mA maximum
Accuracy vs. Temperature Error	±100 ppm / °C maximum

Analog Current Input Circuit

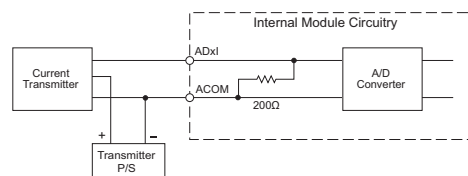

C0-02DR-D Analog Specifications - Current Output	
Outputs per Module	2 (voltage/current selectable)
Output Range	4 - 20 mA
Resolution	12 bit
Conversion Time	1 ms
Loop Supply Voltage	DC 18 - 30 V
Load Impedance	250Ω Load Power Supply: DC 18V: 600Ω maximum DC 24V: 900Ω maximum DC 30V: 1200Ω maximum
Full-Scale Calibration Error	±1% maximum
Offset Calibration Error	±0.1 mA maximum
Accuracy vs. Temperature Error	±100 ppm / °C maximum

Analog Current Output Circuit

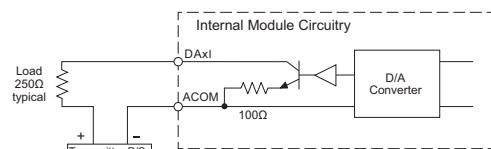

CLICK Specifications

General Specifications For All CLICK PLC Products

These general specifications apply to all CLICK CPUs, optional I/O modules, and optional power supply products. Please refer to the appropriate I/O temperature derating charts under both the CPU and I/O module specifications to determine best operating conditions based on the ambient temperature of your particular application.

General Specifications	
Power Input Voltage Range	20-28 VDC
Maximum Power Consumption	5 W (No 5 V use from communication port)
Maximum Inrush Current	30 A (less than 1ms)
Acceptable External Power Drop	Max 10 ms
Operating Temperature	32°F to 131°F (0°C to 55°C), IEC 60068-2-14 (Test Nb, Thermal Shock)
Storage Temperature	-4°F to 158°F (-20°C to 70°C) IEC 60068-2-1 (Test Ab, Cold) IEC 60068-2-2 (Test Bb, Dry Heat) IEC 60068-2-14 (Test Na, Thermal Shock)
Ambient Humidity	30% to 95% relative humidity (non-condensing)
Environmental Air	No corrosive gases. Environmental pollution level is 2 (UL840)
Vibration	MIL STD 810C, Method 514.2, EC60068-2-6 JIS C60068-2-6 (Sine wave vibration test)
Shock	MIL STD 810C, Method 516.2, IEC60068-2-27, JIS C60068-2-27
Noise Immunity	Comply with NEMA ICS3-304, Impulse noise 1µs, 1000V EN61000-4-2 (ESD), EN61000-4-3 (RFI), EN61000-4-4 (FTB) EN61000-4-5 (Surge), EN61000-4-6 (Conducted) EN61000-4-8 (Power frequency magnetic field immunity) RFI: No interference measured at 150, 450 MHz (5w/15cm)
Emissions	EN55011:1998 Class A
Agency Approvals	UL508 (File No. E157382, E316037); CE (EN61131-2)
Other	RoHS instruction conformity

CPU Module Specifications

These specifications apply to all the CPU modules.

CPU Module Specifications		
	Basic CPU	Analog CPU
Control Method	Stored Program/Cyclic execution method	
I/O Numbering System	Fixed in Decimal	Fixed in Decimal
Ladder Memory (steps)	8000	8000
Total Data Memory (words)	8000	8000
Contact Execution (boolean)	< 0.6 us	< 0.6 us
Typical Scan (1k boolean)	1-2 ms	1-2 ms
RLL Ladder Style Programming	Yes	Yes
Run Time Edits	No	No
Scan	Variable / fixed	Variable / fixed
CLICK Programming Software for Windows	Yes	Yes
Built-in Communication Ports	Yes (two RS-232 ports)	Yes (2 RS-232 and 1 RS-485 ports)
FLASH Memory	Standard on CPU	Standard on CPU
Built-in Discrete I/O points	8 inputs, 6 outputs	4 inputs, 4 outputs
Built-in Analog I/O Channels	No	2 inputs, 2 outputs
Number of Instructions Available	21	21
Control Relays	2000	2000
System Control Relays	1000	1000
Timers	500	500
Counters	250	250
Interrupt	Yes (external: 8 / timed: 4)	Yes (external: 4 / timed: 4)
Subroutines	Yes	Yes
For/Next Loops	Yes	Yes
Math (Integer and Hex)	Yes	Yes
Drum Sequencer Instruction	Yes	Yes
Internal Diagnostics	Yes	Yes
Password Security	Yes	Yes
System Error Log	Yes	Yes
User Error Log	No	No
Memory Backup	Super Capacitor	Super Capacitor + Battery
Battery Backup	No	Yes (battery part no. D2-BAT-1)
Calendar/Clock	No	Yes
I/O Terminal Block Replacement	ADC p/n C0-16TB	ADC p/n C0-16TB
Communication Port & Terminal Block Replacement	N/A	ADC p/n C0-03TB
24 VDC Power Terminal Block Replacement	ADC p/n C0-4TB	ADC p/n C0-4TB

CLICK Specifications

CPU Features

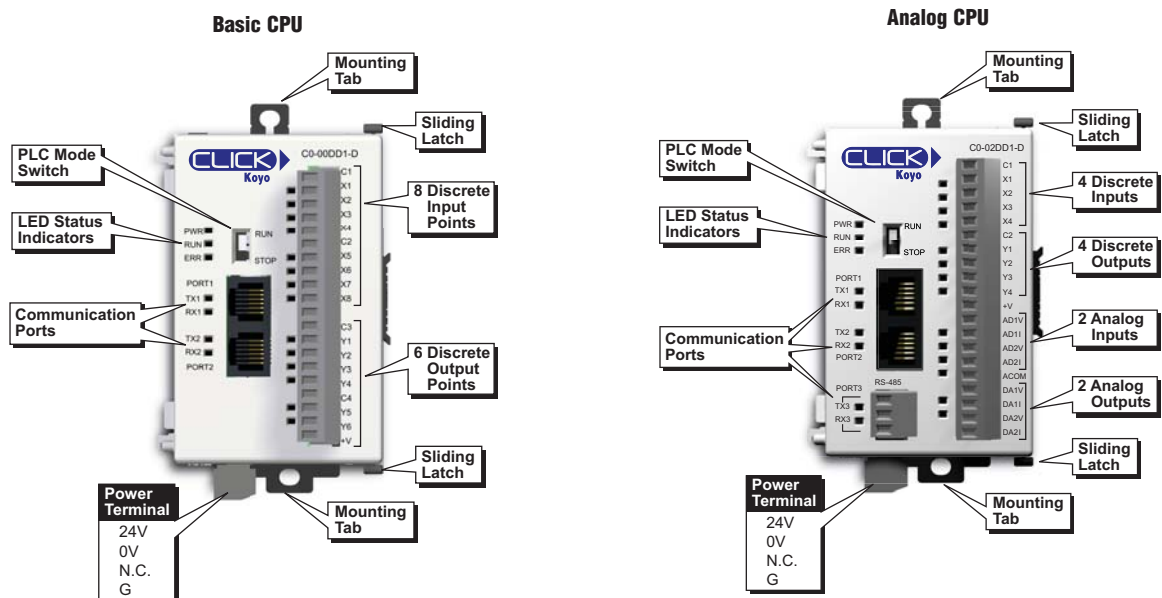

CPU LED Status Indicators

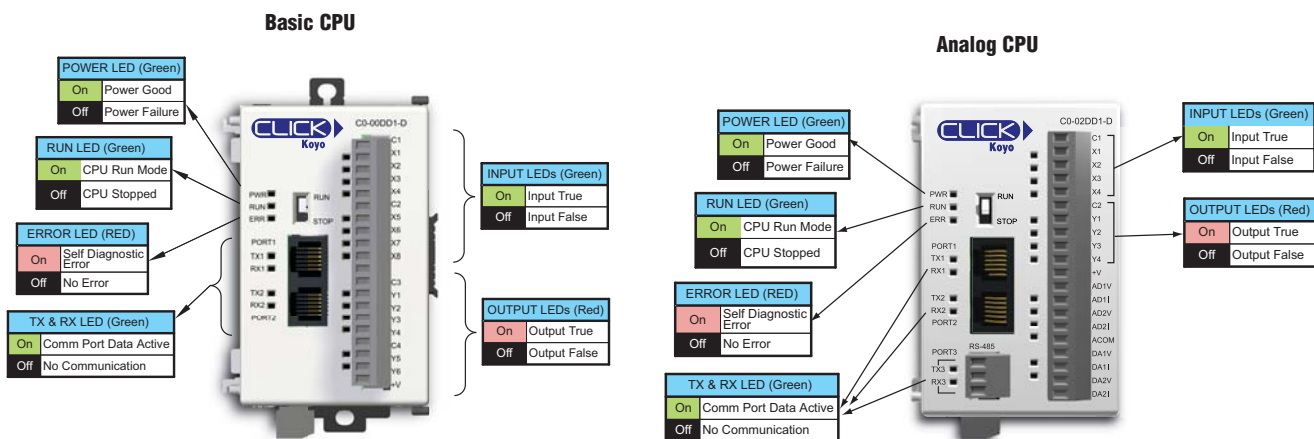

I/O Terminal Block Specifications for CPUs and I/O Modules

11-pin Terminal Block Specifications	
Connector Type	Pluggable Terminal Block
Number of Pins	11 pt
Pitch	3.50 mm
Wire Range	28-16 AWG
Wire Strip Length	7 mm
Screw Size	M2.0
Screw Torque	2.0 to 2.2 lb-inch
ADC Part Number	C0-8TB

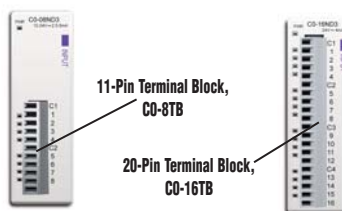

20-pin Terminal Block Specifications	
Connector Type	Pluggable Terminal Block
Number of Pins	20 pt
Pitch	3.50 mm
Wire Range	28-16 AWG
Wire Strip Length	7 mm
Screw Size	M2.0
Screw Torque	2.0 to 2.2 lb-inch
ADC Part Number	C0-16TB

Product Dimensions and Installation

It is important to understand the installation requirements for your CLICK system. Your knowledge of these requirements will help ensure that your system operates within its environmental and electrical limits.

Plan for Safety

This catalog should never be used as a replacement for the user manual.

You can purchase, download free, or view online the user manuals for these products. Manual C0-USER-M is the user manual for the CLICK PLC. This user manual contains important safety information that must be followed. The system installation should comply with all appropriate electrical codes and standards.

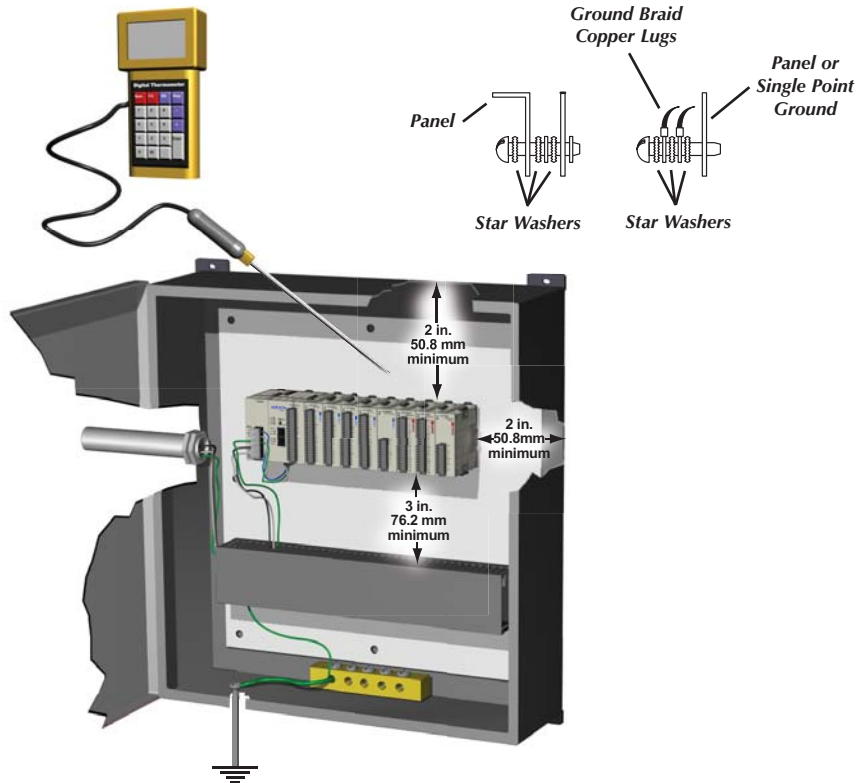

NOTE: THERE IS A MINIMUM CLEARANCE REQUIREMENT OF 2 INCHES (51 MM) BETWEEN THE CLICK PLC AND THE PANEL DOOR OR ANY DEVICES MOUNTED IN THE PANEL DOOR. THE SAME CLEARANCE IS REQUIRED BETWEEN THE PLC AND ANY SIDE OF THE ENCLOSURE. A MINIMUM CLEARANCE OF 3 INCHES (76 MM) IS REQUIRED BETWEEN THE PLC AND A WIREWAY OR ANY HEAT PRODUCING DEVICE.



Mounting Orientation

CLICK PLCs must be mounted properly to ensure ample airflow for cooling purposes. It is important to follow the unit orientation requirements and to verify that the PLC's dimensions are compatible with your application. Notice particularly the grounding requirements and the recommended cabinet clearances.

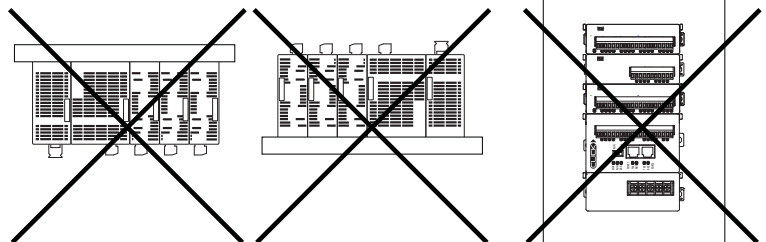
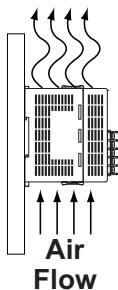

Product Dimensions and Installation

Connecting the Modules Together

CLICK CPUs, I/O modules and power supplies connect together using the extension ports that are located on the side panels of the modules (no PLC backplane/base required).

1. Remove extension port covers and slide the latch tabs forward.
2. Align the module pins and connection plug, and press the I/O module onto the right side of the CPU.
3. Slide the latch tabs backward to lock the modules together.

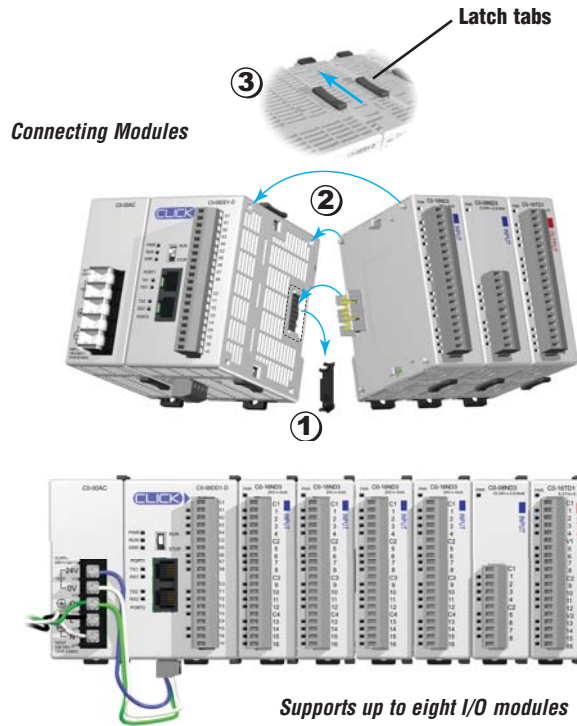

Mounting

The CLICK PLC system, which includes the CLICK power supplies, CPU modules, and I/O modules, can be mounted in one of two ways.

1. DIN rail mounted
2. Surface mounted using the built-in upper and lower mounting tabs.

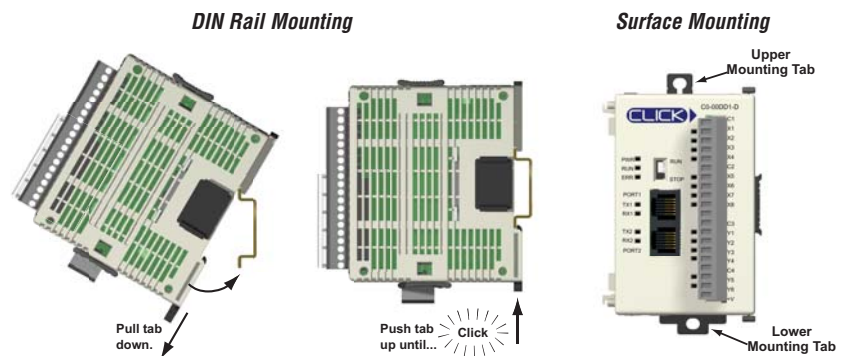

Unit Dimensions

These diagrams show the outside dimensions of the CLICK power supply, CPU, and I/O modules. The CLICK PLC system is designed to be mounted on standard 35mm DIN rail, or it can be surface mounted.

Allow proper spacing from other components within an enclosure.

Maximum system:

Power Supply + CPU + 8 I/O modules.

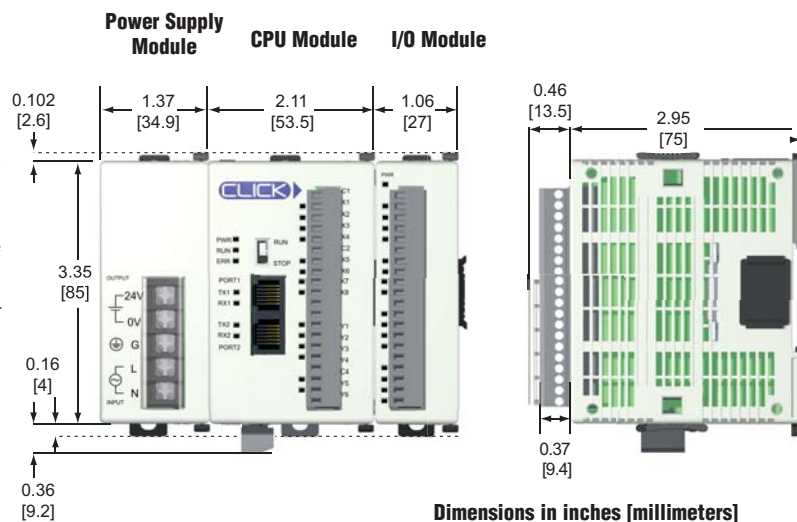

Product Dimensions and Installation

Unit Dimensions

Power Supply

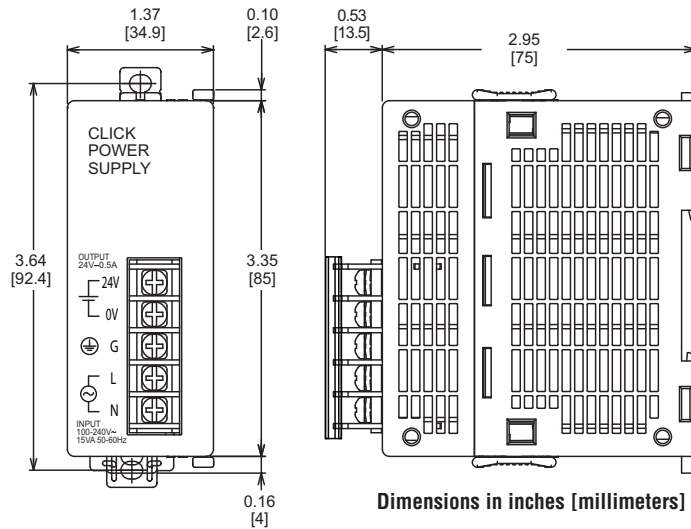

CPU Module

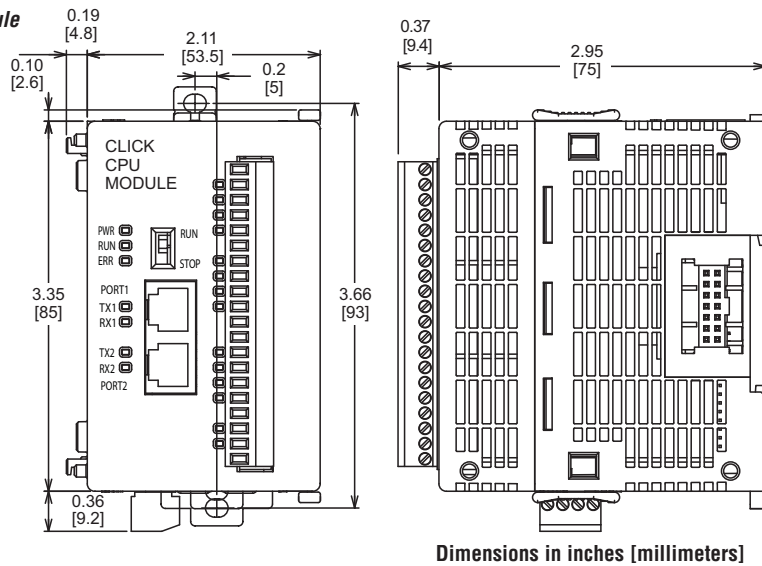

I/O Module

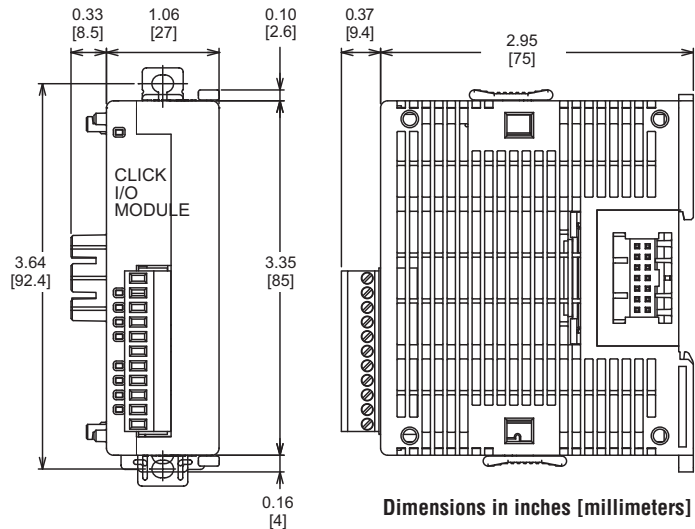

Networking the CLICK PLC

Built-in Communications Ports

All CPUs have two built-in RS-232 communications ports. Analog CPUs also have one built-in RS-485 communications port. One RS-232 port supports the Modbus RTU protocol only and can be used as the programming port. The other ports support either Modbus RTU or ASCII protocol. Both RS-232 ports supply 5 VDC, so you can connect our C-more Micro HMI panel without an additional power supply.

LED Status Indicators

There are LED indicators located to the left of each communication port to indicate when the port is transmitting or receiving.

Basic CPUs Port 1 & 2 LED Status Indicators

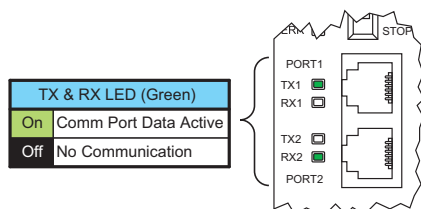

Analog CPUs Port 1, 2, & 3 LED Status Indicators

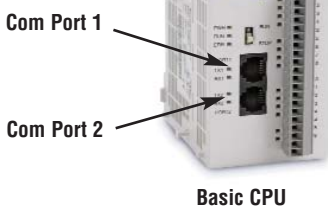
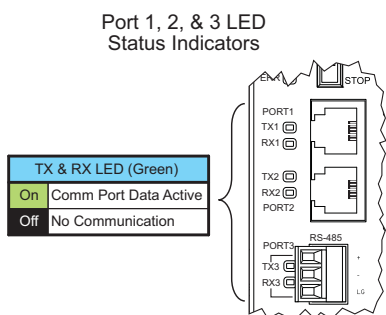

Basic CPU

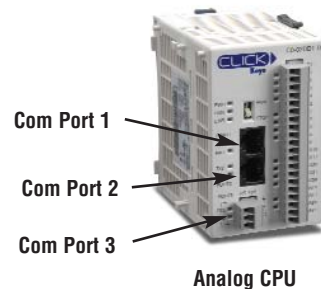

Analog CPU

Com Port 1 Specifications	
Use:	Programming Port
Physical:	6 pin, RJ12, RS-232
Communication speed (baud):	38400 (fixed)
Parity:	Odd
Station Address:	1
Data length:	8 bits
Stop bit:	1
Protocol:	Modbus RTU (slave only)

Port 1
6 pin RJ12 Phone Type Jack

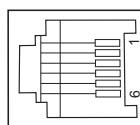

Port 1 Pin Descriptions		
1	0V	Power (-) connection (GND)
2	5V	Power (+) connection
3	RXD	Receive data (RS-232)
4	TXD	Transmit data (RS-232)
5	NC	No connection
6	0V	Power (-) connection (GND)

Com Port 2 Specifications	
Use:	Serial Communication
Physical:	6 pin, RJ12, RS-232
Communication speed (baud):	1200, 2400, 4800, 9600, 19200, 38400, 57600, 115200
Parity:	odd, even, none
Station Address:	1 to 247
Data length:	8 bits (Modbus RTU) or 7, 8 bits (ASCII)
Stop bit:	1,2
Protocol:	Modbus RTU (master/slave) or ASCII in/out

Port 2
6 pin RJ12 Phone Type Jack

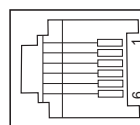

Port 2 Pin Descriptions		
1	0V	Power (-) connection (GND)
2	5V	Power (+) connection
3	RXD	Receive data (RS-232)
4	TXD	Transmit data (RS-232)
5	RTS	Request to send
6	0V	Power (-) connection (GND)

Com Port 3 Specifications	
Use:	Serial Communication
Physical:	3 pin, RS-485
Communication speed (baud):	1200, 2400, 4800, 9600, 19200, 38400, 57600, 115200
Parity:	odd, even, none
Station Address:	1 to 247
Data length:	8 bits (Modbus RTU) or 7, 8 bits (ASCII)
Stop bit:	1,2
Protocol:	Modbus RTU (master/slave) or ASCII in/out

Port 3
RS-485
+
-
LG

Port 3 Pin Descriptions		
1	+ (plus)	Signal A (RS-485)
2	- (minus)	Signal B (RS-485)
3	LG	Logic Ground(0 V)

Port Setup

Use CLICK programming software to easily configure the communication ports.

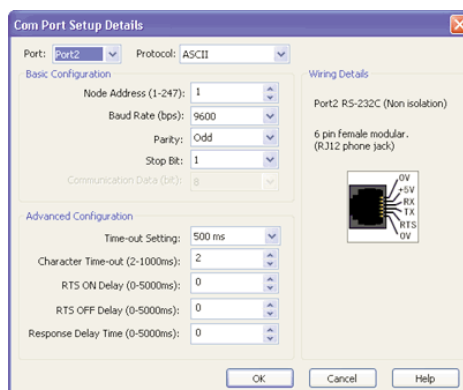

Networking the CLICK PLC

Typical Serial Communication Applications

The diagrams on these two pages illustrate the typical uses for the CLICK CPU's communication ports.

Port 1 (RS-232) – Modbus RTU Slave Mode Only



CLICK CPU

Example

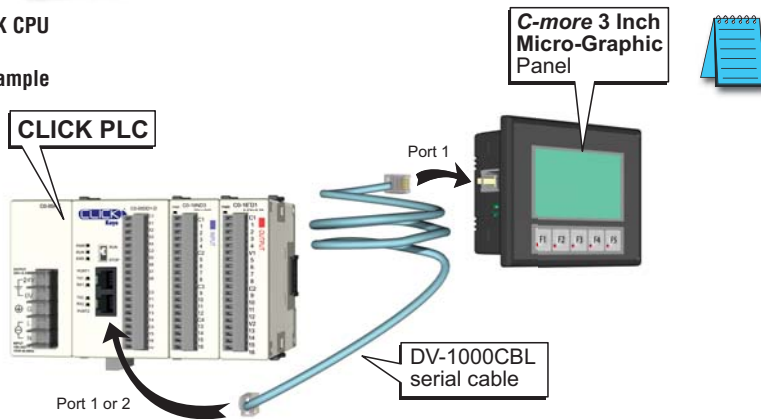

NOTE: A C-more Micro-Graphic panel can be connected to CLICK's Port 1 and/or Port 2. Either port can provide 5 VDC to power the panel, but not at the same time. If a C-more Micro-Graphic panel is connected to both ports, then at least one of the panels must be powered by a C-more DC power adapter, EA-MG-P1 or EA-MG-SP1, or another 24 VDC power source.

Do not use the Following DirectLOGIC Devices with CLICK's Port 1 or 2:



WARNING: The following DirectLOGIC PLC devices cannot be used with a CLICK CPU's Port 1 or Port 2:
 Handheld Programmer for DL05, DL06, DL105, DL205 & D3-350 CPUs, p/n D2-HPP
 Handheld Programmer for DL405 CPUs, p/n D4-HPP-1
 Timer/Counter Access for DL05, DL06, DL105, DL205, DL405 & D3-350 CPUs, p/n DV-1000



D2-HPP



D4-HPP-1



DV-1000

Networking the CLICK PLC

Port 2 (RS-232) – Modbus RTU or ASCII

Port 3 (RS-485; Analog CPUs Only) – Modbus RTU or ASCII

All CPUs have RS-232 port 2, but only analog CPUs have RS-485 port 3. Ports 2 and 3 allow networking to similar devices.

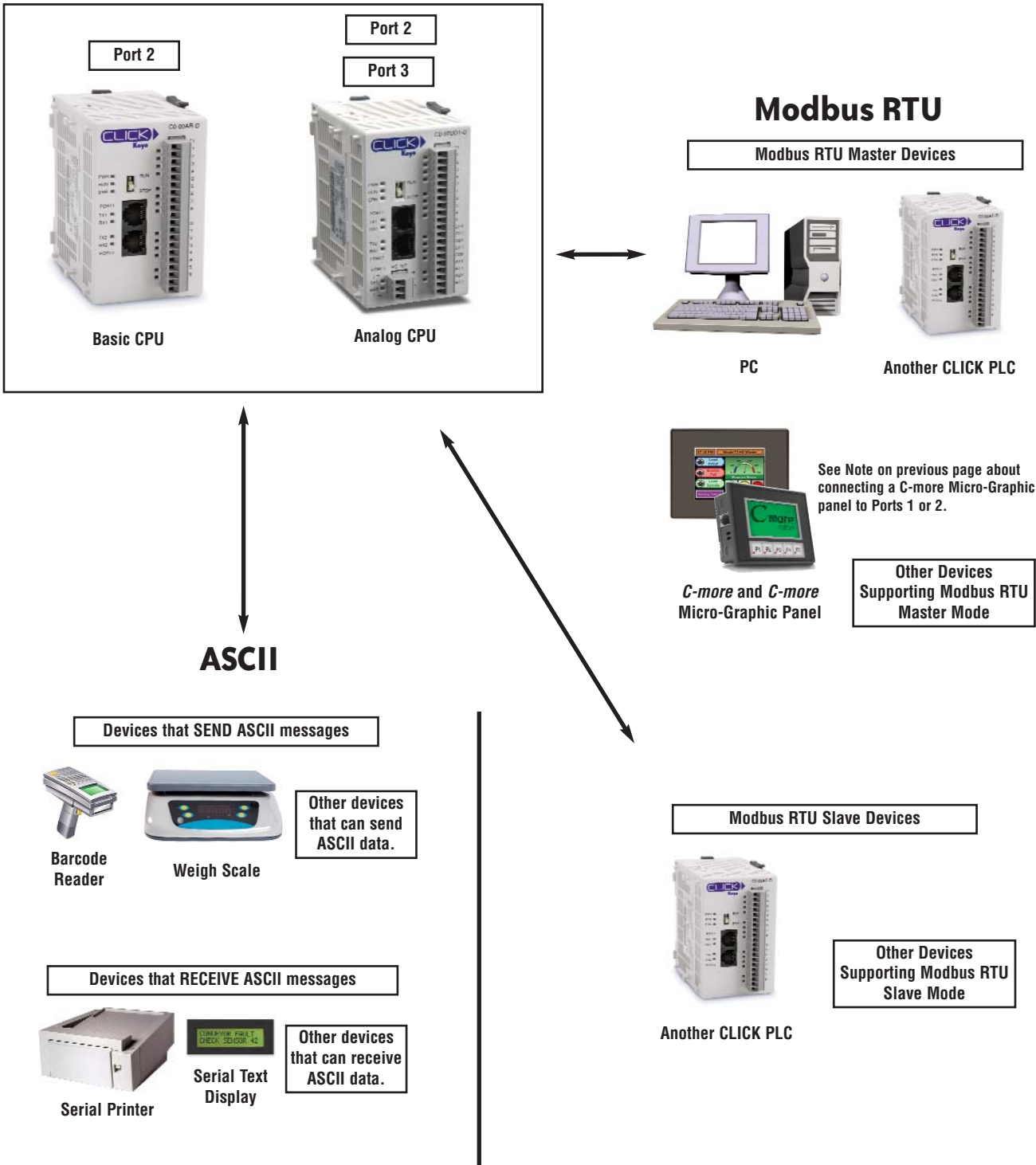

Power Supplies

Power Supplies

The CLICK PLC family offers two 24 VDC power supplies. They are identical except for the output current.

It is not mandatory to use one of these CLICK power supplies for the CLICK PLC system. You can use any other 24 VDC power supply that Automationdirect.com offers.

CO-00AC Power Supply

Limited auxiliary AC power supply allows you to power the 24 VDC CLICK C0 series CPUs with 100-240 VAC supply power. The 0.5A DC power supply is capable of controlling the CPU plus a limited configuration based on the power budget of each I/O module. The CO-00AC is a low-cost solution for applications requiring only minimal I/O and power consumption. This power supply will not support a fully-populated CLICK PLC system with all possible I/O module combinations.

CO-01AC Power Supply

Expanded auxiliary AC power supply allows you to power the 24 VDC CLICK C0 series CPUs with 100-240 VAC supply power. The 1.3A DC power supply is capable of supporting a fully-populated CLICK PLC system with all possible I/O module combinations, with no concerns for exceeding the power budget.

CLICK 24 VDC Power Supply Ratings	
Part Number	Output Current
CO-00AC	0.5 A
CO-01AC	1.3 A

CO-00AC Power Supply Specifications	
Input Voltage Range	85-264 VAC
Input Frequency	47-63 Hz.
Input Current (typical)	0.3 A @ 100 VAC, 0.2 A @ 200 VAC
Inrush Current	30 A
Output Voltage Range	23-25 VDC
Output Current	0.5 A
Over Current Protection	@ 0.65 A (automatic recovery)
Weight	5.3 oz (150g)

CO-01AC Power Supply Specification	
Input Voltage Range	85-264 VAC
Input Frequency	47-63 Hz.
Input Current (typical)	0.9 A @ 100 VAC, 0.6 A @ 200 VAC
Inrush Current	30 A
Output Voltage Range	23-25 VDC
Output Current	1.3 A
Over Current Protection	@ 1.6 A (automatic recovery)
Weight	6.0 oz (170g)

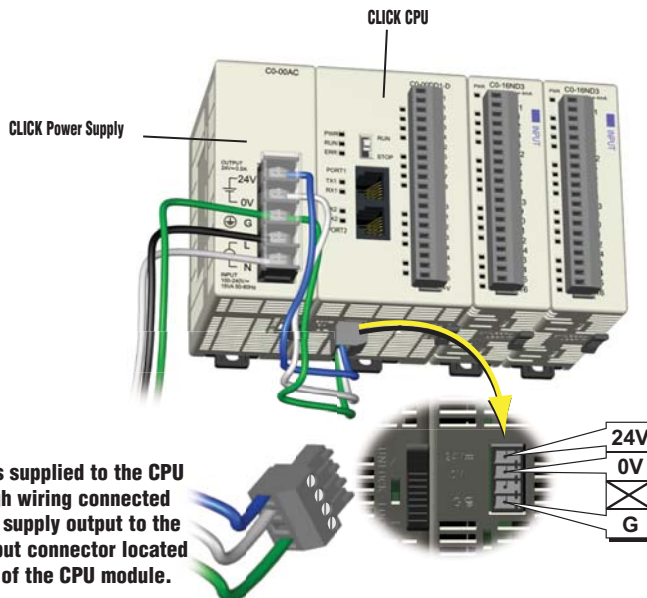
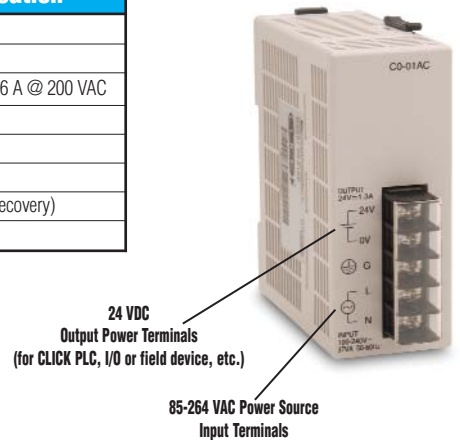
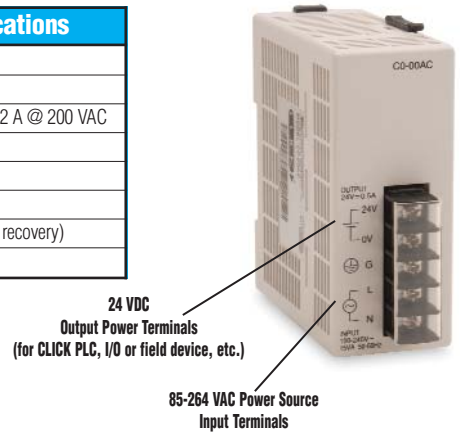

Power Budgeting

Power Budgeting

There are two areas to be considered when determining the power required to operate a CLICK PLC system. The first area is the power required by the CLICK CPU, along with the internal logic side power that the CPU provides to its own I/O and any connected I/O modules that are powered through the CPU's expansion port; plus any device, such as a C-more Micro-Graphic panel, that is powered through one of the CPU's communication ports.

The second area is the power required by all externally connected I/O devices. This should be viewed as the field side power required. The field side power is dependent on the voltage used for a particular input or output device as it relates to the wired I/O point, and the calculated load rating of the connected device.

It is strongly recommended that the power source for the logic side be separate from the power source for the field side to help eliminate possible electrical noise.

Power budgeting requires the calculation of the total current that the 24 VDC power source needs to provide to CLICK's logic side, and also a separate calculation of the total current required for all devices operating from the field side of the PLC system.

See the Power Budgeting Example shown to the right. The table shows current requirements for a CLICK CPU, two I/O modules, and a C-more Micro. Use the total amperage values to select a proper sized power supply.

Power Budgeting Using the CLICK Programming Software

The following example shows the logic side current consumption as calculated in the CLICK Programming software. Based on the amperage rating of the power supply selected in the first column, your power budget is calculated by subtracting each consecutive module's power consumption from the total available power budget. If you exceed the maximum allowable power consumption the power budget row is highlighted in red.

Power budget row turns red if maximum allowable power consumption is exceeded for the power supply selected.



CLICK 24 VDC Power Supply
CO-00AC or CO-01AC



Other 24 VDC Power Supply
Example: PSP24-60S

Current Consumption (mA)		
Part Number	Power Budget 24 VDC (logic side)	External 24 VDC (field side)
Basic CPU Modules		
CO-00DD1-D	120	60
CO-00DD2-D	120	0
CO-00DR-D	120	0
CO-00AR-D	120	0
Analog CPU Modules		
CO-02DD1-D	120	60
CO-02DD2-D	120	0
CO-02DR-D	120	0
Input Modules		
CO-08ND3	30	0
CO-08ND3-1	30	0
CO-16ND3	40	0
CO-08NA	30	0

Current Consumption (mA)		
Part Number	Power Budget 24 VDC (logic side)	External 24 VDC (field side)
Output Modules		
CO-08TD1	50	15
CO-08TD2	50	0
CO-16TD1	80	100
CO-16TD2	80	0
CO-08TA	80	0
CO-04TRS	100	0
CO-08TR	100	0
C-more Micro-Graphic Panel		
All p/n	90	0

Power Budgeting Example

Current Consumption (mA) Example		
Part Number	Power Budget 24 VDC (logic side)	External 24 VDC (field side)
CO-00DD1-D	120	60
CO-16ND3	40	0
CO-16TD1	80	100
C-more Micro	90	0
Total:	330	160 *

* Plus calculated load of connected I/O devices.

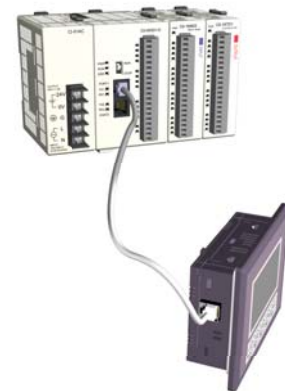

System Configuration Setup

Start-up I/O Config Check

CO-00AC CPU CO-00DR-D CO-16ND3 CO-08ND3 CO-08NA CO-16TD1 CO-04TRS CO-08TR

System Input Total(pt)=40 Output Total(pt)=34 Power Budget(mA)=520(-20)

Name	P/S	CPU	I/O 1	I/O 2	I/O 3	I/O 4	I/O 5	I/O 6	I/O 7	I/O 8
Module Type	CO-00AC	CO-00DR-D	CO-16ND3	CO-08ND3	CO-08NA	CO-16TD1	CO-04TRS	CO-08TR		
Input		X001-X008	X101-X116	X201-X208	X301-X308					
Output		Y001-Y006				Y401-Y416	Y501-Y504	Y601-Y608		
PwrBudget(mA)	520	120	40	30	30	80	100	120		

Buttons: Change... Remove Select... OK Cancel Help