

# C-more 6" Micro-Graphic STN Touch Panel

Model EA1-S6MLW **C-more** 6" Micro-Graphic touch panel has a 5.7-inch STN LCD monochrome 320 x 240 dot display and five selectable LED-driven backlight colors including White, Pink1, Pink2, Pink3 and Red. It features five user-defined function keys, each key with a user-defined red LED indicator. The panel can display up to 40 lines by 80 characters of static text and up to 40 lines by 40 characters of dynamic text with embedded variables and phrases mixed with graphics in landscape orientation. Portrait orientation can display 53 lines by 60 characters of static text and 40 lines by 40 characters of dynamic text. It is rated UL for use on a flat surface of Type 1, 4X enclosure (for indoor use only). The **C-more** 6" Micro-Graphic STN panels are powered from a 12-24 VDC power supply or can operate in low-power mode\* when powered from the serial communications port of select AutomationDirect PLCs.

Part No. EA1-S6MLW

Shown in Landscape (Horizontal) mode



## Features

- Touch screen display
- Free downloadable programming software
- 320 x 20 Dot display with up to 40 lines by 80 characters of text and graphics in landscape mode
- Up to 40 lines by 40 characters of dynamic text with embedded variables and phrases mixed with graphics
- 5 programmable function keys can change with every screen. Can increment / decrement values, trigger recipes, view index of screens.
- 5-Color LED backlight for longer lifetime; Green, Red, Amber, Yellow and Lime
- 2 optional keypad bezels, 20-button landscape and 21-button portrait
- Optional replaceable clear screen overlay
- 1,792 KB memory
- Built in RJ12 serial communications port
- Built in 15-pin serial communications port
- Built in Alarm Control setup that activates beep, backlight flash, customized alarm banner, and red LED blinking
- 0 to 50 °C (32 to 122 °F) operating temperature range (IEC 60068-2-14)
- NEMA 4/4X, IP65 compliant when mounted correctly, indoor use only
- UL, cUL & CE agency approvals
- 2-year warranty from date of purchase



**\*NOTE: When EA1-S6ML or EA1-S6MLW is powered through Port1 from a connected PLC or PC, the screen brightness is diminished because the panel is running in Low-Power Mode. For full brightness, connect an external 12-24 VDC power source to the 6" panel's power connection. Low-Power Mode should be used during initial programming only. Connect an external 12-24 VDC power source when the panel is installed in its application.**

## Dimensions

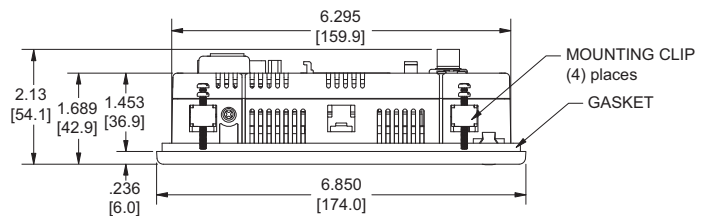

Units: Inches [mm]

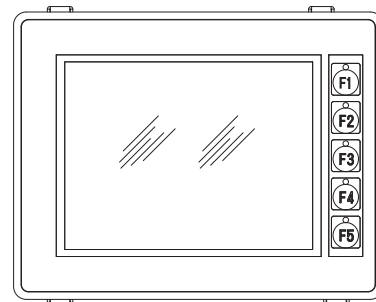
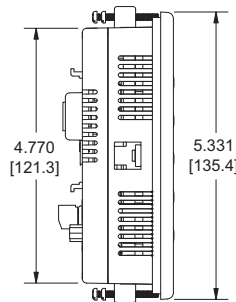

**NOTE: Don't forget the optional keypad bezels shown in the Accessories section.**

## Panel Cutout

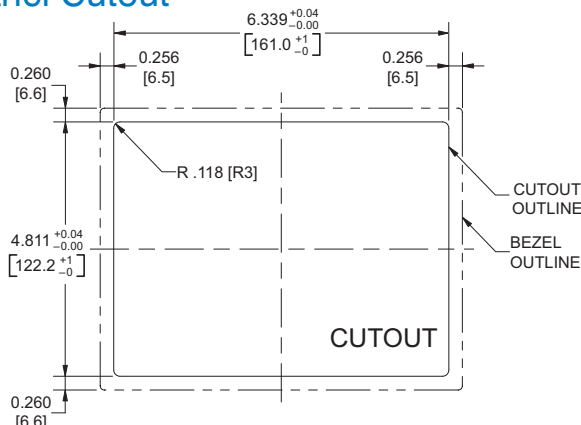

## Panel Thickness

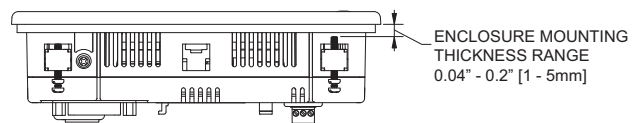

**NOTE: The C-more 6" Micro-Graphic cutout dimensions are not equivalent to previous AutomationDirect text panels. The C-more 6" Micro-Graphic panels will not fit in cutouts for DV-1000, EZText, Optimate panels or C-more 6" panels.**

# C-more 6" Micro-Graphic Panels Overview

## Overview

**C-more 6"** Micro-Graphic panels are joined by a full color, TFT model! **C-more 6"** Micro-Graphic panels offer touch screen capability and customizable graphics. Two optional Keypad Bezels are available for either Horizontal or Vertical panel orientation.

In addition to the simple panel configuration software, a very helpful feature is the built-in project simulator. The project simulator allows you to view your project on the PC screen as it would appear on the panel and to test all your screens before downloading the project to the panel. You can simulate your entire project at any stage of development. With version 2.50 or later, simulate the function keys and keypad bezel.

## Support

Our Web site contains all of the information in this section, any new feature releases, tech support, plus much more. Please visit [www.automationdirect.com](http://www.automationdirect.com), or visit [www.C-moreMicro.com](http://www.C-moreMicro.com) for a more interactive presentation. You may also contact our Technical Support group from 9 a.m. to 6 p.m. ET, Monday - Friday, at 770-844-4200 and we will be glad to assist you.

## Getting started

Installing the software and configuring the **C-more 6"** Micro-Graphic panel is simple. You will need the following to successfully connect and configure a project for the panel:

- **C-more 6"** Micro-Graphic panel
- **C-more** Micro-Graphic Programming Software, EA-MG-PGMSW
- Programming cable: EA1-S6ML and EA1-S6MLW require the **C-more** Micro-Graphic USB to RS232 converter with cables, EA-MG-PGM-CBL; used to connect the panel to your PC's USB port and run the **C-more** Micro-Graphic programming software.
- Programming cable: EA1-T6CL uses a standard USB A-to-B type cable to connect the panel to your PC's USB port and run the **C-more** Micro-Graphic programming software. AutomationDirect.com sells USB A-to-B cables in a variety of lengths such as USB-CBL-AB6 (6 foot length).
- PLC communications cable (serial) to connect the **C-more** Micro-Graphic panel to your controller

## Drivers for your Controller

**C-More 6"** Micro-Graphic panels have the following drivers available for connection to AutomationDirect DirectLOGIC and many other controllers:

- AutomationDirect CLICK (Modbus)
- DirectLOGIC K-sequence, DirectLOGIC DirectNET, DirectLOGIC Modbus (Koyo Addressing)
- Modbus RTU
- Allen Bradley DF1 Full Duplex, Allen Bradley DF1 Half Duplex, Allen Bradley PLC5 DF1, AB DH485
- Omron Host Link (C200 Adapter, C500), Omron FINS serial (CJ1, CS1),
- GE SNPX (90/30, 90/70, Micro 90, VersaMax Micro)
- Mitsubishi Melsec FX
- Mitsubishi Q and QnA
- Siemens PPI
- Entivity Modbus RTU

### EA1-S6ML



Shown in Landscape (Horizontal) mode

### EA1-S6MLW



Shown in Portrait (Vertical) mode

### EA1-T6CL



Shown in Portrait (Vertical) mode



**NOTE: EA1-T6CL requires Software and Firmware Version 2.50 or later. Software and Firmware Version 2.0 or later is required with models EA1-S6ML and EA1-S6MLW. Available for free download at [www.automationdirect.com](http://www.automationdirect.com).**

## Features

### Bitmaps

- 320 X 240 pixel graphical display supports bitmaps
- Use bitmap images of pushbuttons, switches, indicators, your company logo
- Use provided library of bitmaps
- Create your own library of bitmaps

### Text - 40 lines

- 40 lines by 80 characters of static text in Landscape Orientation
- 53 lines by 60 characters of static text in Portrait Orientation
- Look up text, scroll up to 128 characters
- 40 lines by 40 characters of dynamic text, embedded variables, on/off phrases, scroll up to 40 characters
- Scroll text object with up to 128 characters
- Inverse video to accentuate text

### Beep

- Beep to indicate an alarm
- Beep for a special message
- Beep to verify when button is pressed

### Bar graphs

- Line, vertical, horizontal, skinny, fat, multiple

### Data entry

- Pop-up numeric key pad on the screen
- Increment/decrement a value by touching arrows
- Two optional keypad bezels, Landscape and Portrait

### Recipes

Each recipe button transfers up to 99 values from PLC source registers to PLC destination registers and/or from the recipe table to PLC destination registers.

### 5 dynamic background colors - EA1-S6ML and EA1-S6MLW

Screen background can be controlled by the program to choose one of five colors depending upon the model. Choices for model EA1-S6ML are green, lime, yellow, amber and red. Model EA1-S6MLW background colors include white, pink1, pink2, pink3 and red. For example, use a red background for an alarm condition or a yellow background on a caution screen that will be easily noticed.



EA1-S6ML



EA1-S6MLW

### 32K Colors - EA1-T6CL

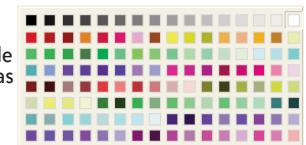

The TFT panel has a palette of 32K colors available to make full use of color for objects and bitmaps as well as backgrounds.



### Up to 999 Screens

**C-more** Micro-Graphic supports up to 999 screens. Screen quantity is limited by memory usage which is determined by the total bitmaps, objects, etc. that are used.

# C-more 6" Micro-Graphic Panels Overview



C-more 6" STN Micro-Graphic Panels		
Part Number	Description	Price
EA1-S6ML	 <p>5.7-inch <b>C-more</b> Micro-Graphic Touch Panel with STN LCD monochrome, 320x240 dot display. The panel has red and green LED backlights. Supports 5 selectable backlight colors (Red, Green, Amber, Lime, and Yellow). Includes 5 user-defined function keys with LED indicators. 2 built in serial Ports (RS-232 RJ12 port and 15 pin D-sub RS-232/422/485). NEMA 4/4X, IP65 (when mounted correctly; for indoor use only).</p>	<--->
EA1-S6MLW	 <p>5.7-inch <b>C-more</b> Micro-Graphic Touch Panel with STN LCD monochrome, 320x240 dot display. The panel has white and red LED backlights. Supports 5 selectable backlight colors (White, Pink1, Pink2, Pink3, and Red). Includes 5 user-defined function keys with LED indicators. 2 built in serial Ports (RS-232 RJ12 port and 15 pin D-sub RS-232/422/485). NEMA 4/4X, IP65 (when mounted correctly; for indoor use only).</p>	<--->
EA-MG-PGM-CBL	 <p>The STN monochrome panels require the USB to serial assembly to connect a personal computer to the panel for programming. (Note: This cable assembly uses the PC's USB port and converts the signals to serial transmissions. The USB port supplies 5 VDC to the Micro-Graphic panel for configuration operations). Assembly includes standard USB A-type connector to B-type connector cable, custom converter, and an RS232C cable with RJ12 modular connector on each end.</p>	<--->



**\*NOTE: C-more Micro-Graphic panels with the letter "W" in the part number designate units with 5 selectable background colors of White, Pink1, Pink2, Pink3 and Red. Part numbers without the letter "W" are provided with 5 selectable background colors of Green, Red, Amber, Yellow and Lime.**



**Note: Software and Firmware Version 2.0 or later is required with models EA1-S6ML and EA1-S6MLW. Available for free download at [www.automationdirect.com](http://www.automationdirect.com).**

C-more 6" TFT Micro-Graphic Panel		
Part Number	Description	Price
EA1-T6CL	 <p>5.7-inch C-more Micro-Graphic Touch Panel with TFT Color LCD, 320 x 240 dot, 32,768 color display with LED backlight. 5 user-defined function keys with LED indicators. Two built-in ports (USB Type-B port and 15-pin D-sub RS-232/422/485 port). Display supports Portrait and Landscape modes. NEMA 4/4X, IP65 (when mounted correctly; for indoor use only).</p>	<--->
USB-CBL-AB3	 <p>The C-more Micro-Graphic TFT panel requires a USB A-to-B type cable to connect a personal computer to the panel for programming. (Note: The TFT panel includes a built-in USB to serial converter and the USB driver will appear as a COM port to the PC when properly installed. The USB port supplies 5VDC to the TFT panel so that no external power supply is required for programming.)</p>	<--->
USB-CBL-AB6		<--->
USB-CBL-AB10		<--->
USB-CBL-AB15		<--->





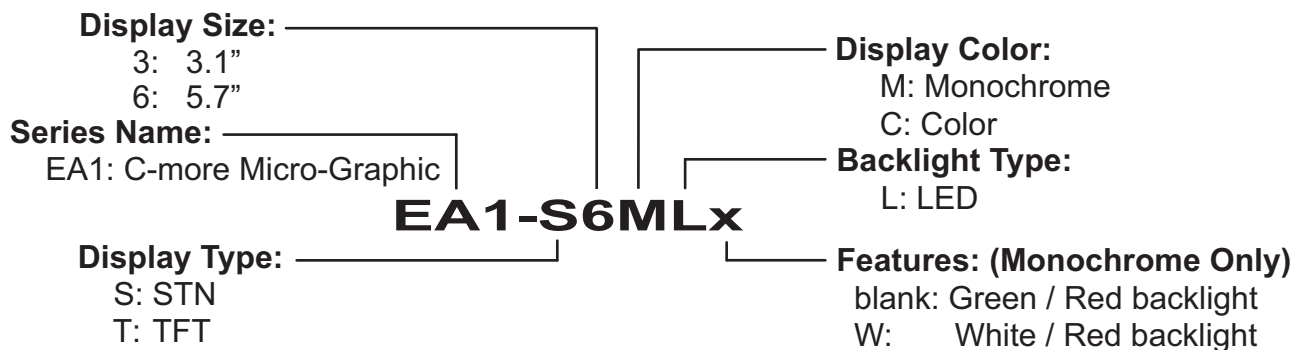

**Note: Software and Firmware Version 2.5 or later is required with model EA1-T6CL. Available for free download at [www.automationdirect.com](http://www.automationdirect.com).**

## C-more 6" Micro-graphic panel part number key:



# C-more 6" Micro-Graphic Panels Overview

C-more Micro-Graphic Programming Software		
Part Number	Description	Price
EA-MG-PGMSW	 <p>C-more Micro-Graphic panel Windows-based configuration software. Requires Windows 2000 with Service Pack 4, XP Home or Professional with Service Pack 2 or Vista. Requires USB port connection from PC to touch panel. Includes CD-ROM. Programming cable sold separately. Downloadable version available from the Web site at no charge. Software Help Files included in download. Programs all C-more Micro-Graphic panels.</p>	<--->

C-more 6" Micro-Graphic Panel Accessories		
Part Number	Description	Price
EA-MG6-BZ2	 <p>For Landscape (Horizontal) Mounted Panels. 20-button keypad bezel with numeric keypad for C-more 6" Micro-Graphic panels, 4 arrow adjust keys, and ESCAPE, MENU, CLEAR and ENTER buttons. Helps to reduce screen wear in heavy-duty applications where operators can use the keypad to enter numeric data. Designed for easy drop-in of the Micro-Graphic panels.</p>	<--->
EA-MG6-BZ2P	 <p>For Portrait (Vertical) Mounted Panels. 21-button keypad bezel with numeric keypad for C-more 6" Micro-Graphic panels, 4 arrow adjust keys, and ESCAPE, MENU, CLEAR and (2) ENTER buttons. Helps to reduce screen wear in heavy-duty applications where operators can use the keypad to enter numeric data. Designed for easy drop-in of the Micro-Graphic panels.</p>	<--->
EA-6-COV2	 <p>Optional clear screen overlay used to protect C-more 6" Micro-Graphic displays from minor scratches and wear. Package contains 3 clear screen overlays.</p>	<--->

PLC Drivers	
Serial - port1 or port2	Serial - port2 only
AutomationDirect CLICK	Allen-Bradley DF1 Full Duplex
AutomationDirect K-sequence	Allen-Bradley DF1 Half Duplex
AutomationDirect DirectNET	Allen-Bradley PLC5 DF1
AutomationDirect Modbus	Allen-Bradley DH485
Modicon Modbus RTU	GE SNPX (90/30, 90/70, Micro 90, VersaMax Micro)
Entivity Modbus RTU	Mitsubishi FX
	Mitsubishi Q & QnA
	Omron Host Link (C200 Adapter, C500)
	Omron FINS Serial (CJ1, CS1)
	Siemens PPI (S7-200 CPU)



**\*NOTE: EA1-T6CL cannot be powered by a PLC and cannot communicate with a PLC through Port1**



# C-more 6" Micro-Graphic Specifications

Specifications			
	EA1-S6ML	EA1-S6MLW	EA1-T6CL
<b>Description</b>	320 x 240 dots LCD display (Landscape Mode), five user defined keypad function buttons, and five user defined LED's		
<b>Display</b>			
• <b>Type</b>	5.7" STN monochrome LCD, graphical characters		5.7" TFT Color LCD, graphical characters
• <b>Resolution</b>	320 (W) x 240 (H) dots (Landscape Mode) 240 (W) x 320 (H) dots (Portrait Mode)		
• <b>Color</b>	2 colors (normal / inverse)		32768 colors
• <b>Viewing Area Size</b>	4.614" (W) x 3.480" (H) [117.2 mm x 88.4 mm]		4.574" (W) x 3.483" (H) [116.2 mm x 87.4 mm]
• <b>Active Area Size</b>	4.535" (W) x 3.400" (H) [115.2 mm x 86.4 mm]		
• <b>Contrast</b>	Adjusted from the panel's built-in configuration setup menu		
• <b>Viewing Angle</b>	3, 9 o'clock axis → 45 degrees 6 o'clock axis → 40 degrees 12 o'clock axis → 20 degrees		3, 9 o'clock axis → 50 degrees 6 o'clock axis → 50 degrees 12 o'clock axis → 45 degrees
<b>Backlight</b>			
• <b>Type</b>	LED		
• <b>Color</b>	5 user defined colors: <b>EA1-S6ML</b> - Red, Green, Amber, Lime, and Yellow <b>EA1-S6MLW</b> - White, Pink1, Pink2, Pink3 and Red		White
• <b>User Replaceable</b>	No		
<b>Touch Screen</b>			
• <b>Type</b>	Analog touch panel		
• <b>Operation</b>	82 gram force [0.8 N] maximum		
• <b>Life</b>	Minimum of 1,000,000 cycles		
<b>Features</b>			
• <b>User Memory</b>	1792 kBytes		3276 kBytes
• <b>Number of Screens</b>	Up to 999 – limited by project memory usage		
• <b>Beep (Internal)</b>	Yes		
• <b>Keypad Function Buttons</b>	Five user defined function key buttons with the ability to customize label with an overlay. Minimum of 500,000 cycles		
• <b>Keypad Function Button LEDs</b>	Each function key button includes a red LED that can be user programmed.		
• <b>Programming Port</b>	RJ12		USB Type B
• <b>Serial Communications</b>	Built-in RJ12 serial communications port (RS-232) and 15-pin D-sub serial communications port (RS-232, RS-485 / 422).		15-pin D-sub serial communications port (RS-232, RS-485 / 422)
• <b>Expansion Connection</b>	Yes – used with optional Keypad Bezels, EA-MG6-BZ2 & EA-MG6-BZ2P		
<b>Screen Objects</b>			
• <b>Functional Devices</b>	Push Button, Switch, Indicator Button, Indicator Light, Graphic Indicator Light, Numeric Display, Numeric Entry, Inc/Dec Value, Bar Graph, Bitmap Button, Static Bitmap, Dynamic Bitmap, Recipe Button, Static Text, Lookup Text, Dynamic Text, Screen Change Push Button, Screen Selector, Adjust Contrast, Function, Key Configuration Object, Real Time Graphics Line Graph, Analog Meter.		
• <b>Static Shapes</b>	Lines, Rectangles, Circles and Frames		
• <b>Displayable Fonts</b>	Fixed fonts: 6x6, 6x8, 8x16, 16x16, 32x16, 32x32, and Windows fonts		
<b>Physical</b>			
• <b>Dimensions</b>	6.850" (W) x 5.331" (H) x 2.130" (D) [174.0 mm x 135.4 mm x 54.1 mm] (Landscape Mode) 5.331" (W) x 6.850" (H) x 2.130" (D) [135.4 mm x 174.0 mm x 54.1 mm] (Portrait Mode)		
• <b>Enclosure Mounting Thickness Range</b>	0.04" – 0.2" [1 – 5 mm]		
• <b>Mounting Clip Screw Torque Range</b>	21 – 28 oz-in [0.15 – 0.2 Nm]		
• <b>Depth from bezel rear with options Module</b>	1.894" [47.1 mm]		
• <b>Weight</b>	30.69 oz. (870 g)		



# C-more 6" Micro-Graphic Specifications

Specifications	
	EA1-S6ML EA1-S6MLW EA1-T6CL
<b>Environmental</b>	
• <b>Operating Temperature</b>	0 to 50 °C (32 to 122 °F) Maximum surrounding air temperature rating: 50 °C
• <b>Storage Temperature</b>	-20 to +60 °C (-4 to +140 °F)
• <b>Humidity</b>	5-95% RH (non-condensing)
• <b>Environmental Air</b>	For use in Pollution Degree 2 environment
• <b>Vibration</b>	IEC60068-2-6 (Test Fc), 5-9 Hz: 3.5 mm amplitude, 9-150 Hz: 1.0G, sweeping, at a rate of 1 octave/min. (±10%), 10 sweep cycles per axis on each of 3 mutually perpendicular axes
• <b>Shock</b>	IEC60068-2-27 (Test Ea), 15 G peak, 11 ms duration, three shocks in each direction per axis, on 3 mutually perpendicular axes (total of 18 shocks)
• <b>Noise Immunity</b>	NEMA ICS3-304 RFI, (145 MHz, 440 MHz 10 W @ 10 cm) Impulse 1000 V @ 1 µs pulse
• <b>Enclosure</b>	For use on a flat surface of Type 1, 4X enclosure (Indoor use only)
• <b>Agency Approvals</b>	CE (EN61131-2), UL508, CUL Canadian C22.2 No. 142-M95, UL File E157382



**NOTE:** The environmental specifications for the panels shown above are also applicable for the C-more 6" Micro-Graphic accessories shown later in this section of the catalog.

Specifications	
EA1-S6ML and EA1-S6MLW	
<b>Electrical</b>	
	<b>Low Power Mode*</b>
	<b>High Power Mode</b>
• <b>Input Voltage Range</b>	5.0 VDC (4.75 – 5.25 VDC)
• <b>Input Power</b>	Supplied through the panel's RJ12 serial communications port connection when used with most AutomationDirect PLCs having a RJ12 communication port or from a PC USB.
• <b>Power Consumption</b>	1.05 W (220 mA@4.75 VDC)
• <b>Recommended Fuse</b>	No fuse required when directly connected to a PLC or PC with recommended cable.
• <b>Maximum Inrush Current</b>	1 A for 500 µs
• <b>Acceptable External Power Drop Duration</b>	Maximum 1 ms



**\*NOTE:** When the 6" panel is powered through Port1 from a connected PLC or PC, the screen brightness is diminished because the panel is running in Low-Power Mode. For full brightness, connect an external 12-24 VDC power source to the 6" panel's power connection. Low-Power Mode should be used during initial programming only. Connect an external 12-24 VDC power source when the panel is installed in its application.

Specifications	
EA1-T6CL	
<b>Electrical</b>	
	<b>USB Bus Power (Programming only)*</b>
	<b>High Power Mode</b>
• <b>Input Voltage Range</b>	5.0 VDC (4.75 – 5.25 VDC)
• <b>Input Power</b>	Supplied from a PC USB.
• <b>Power Consumption</b>	2 W (420 mA @ 4.75 VDC)
• <b>Recommended Fuse</b>	No fuse required when directly connected to a PLC or PC with recommended cable.
• <b>Maximum Inrush Current</b>	4.5 A for 800 µs
• <b>Acceptable External Power Drop Duration</b>	Maximum 1 ms



**\*NOTE:** The EA1-T6CL can be powered through Port1 when connected to a PC for programming, the screen brightness is diminished because the panel is running in Low-Power Mode. For full brightness, connect an external 12-24 VDC power source to the 6" panel's power connection. An external 12-24 VDC power source must be used when the panel is installed in its application.

# C-more 6" Micro-Graphic Power Connection Wiring

## Providing power to the touch panel

- 1.) During operation, the panel functions in High-Power Mode when powered by a minimum 1 Amp 12 - 24 VDC power source. Recommended power supplies are AutomationDirect part number PSP24-024S or PSP24-024C.
- 2.) C-more Micro-Graphic STN panels EA1-S6ML and EA1-S6MLW are powered during programming from the PC through the USB to RS-232 Programming Cable Assembly, EA-MG-PGM-CBL. C-more Micro-Graphic TFT panel EA1-T6CL is powered during programming through a USB A-to-B cable such as USB-CBL-AB6. The panel will operate in Low-power mode when powered by the PC and result in a dim screen.\*
- 3.) Optionally, the C-more Micro-Graphic STN panels EA1-S6ML and EA1-S6MLW can function in Low-Power Mode powered from most AutomationDirect PLC's RJ12 serial communications port. Use a DV-1000CBL communications cable, or a DV-1000CBL communications cable with a FA-15HD 15-pin HD DSub/RJ12 Adapter connected to most AutomationDirect PLC's 15-pin HD communications port (DL06, D2-250-1 & D2-260) for Low-Power operation. See Chapter 6: PLC Communications in the Hardware User's Manual (P/N: EA1-MG6-USER-M) for additional details. The panel will operate in low-power mode when powered by the PLC. The C-more Micro-Graphic TFT panel EA1-T6CL cannot be powered from a PLC.

## EA1-S6ML or EA1-S6MLW powered from an AutomationDirect PLC via communications cable

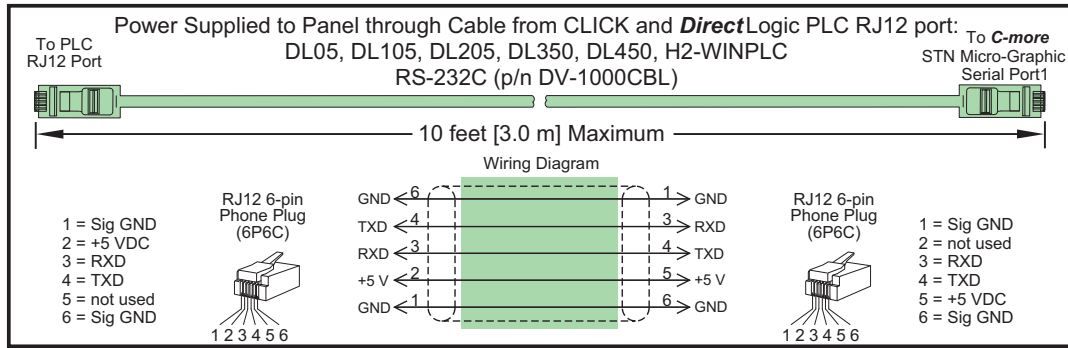

**\*NOTE:** When the panel is powered through Port1, the screen brightness is diminished. For full brightness, connect an external 12-24 VDC power source to the panel's power connection. Low-Power Mode should be used during initial programming only. Connect an external 12-24 VDC power source when the panel is installed in its application.

## 6" Panel powered from a DC power source – wiring diagram

### EA1-S6ML & EA1-S6MLW

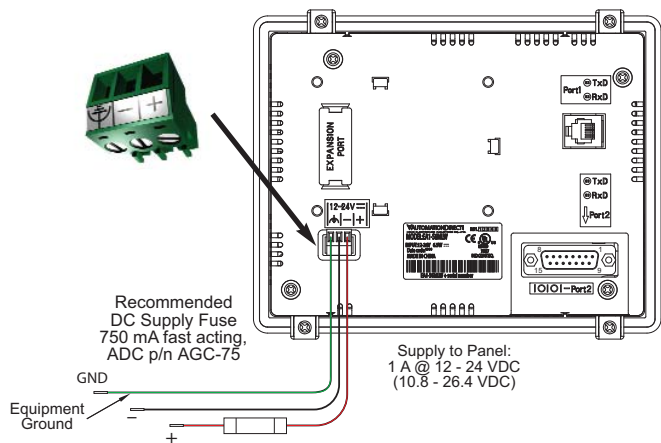

### EA1-T6CL

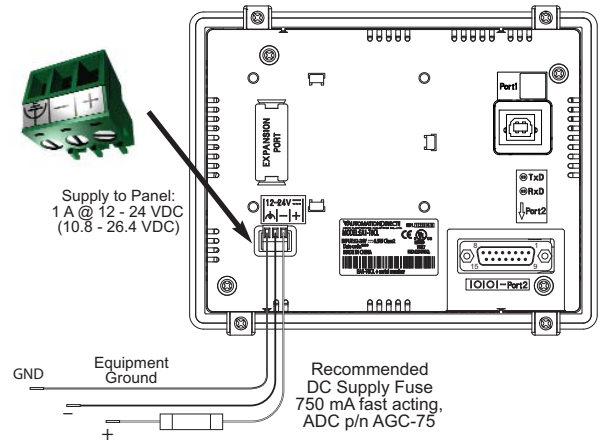

**NOTE:** Recommended DC power supply to power the C-more Micro-Graphic Panel, AutomationDirect Part No. PSP24-024S or PSP24-024C.

# C-more 6" Micro-Graphic PLC Connections

## Cabling requirements

When using the built in RJ12 serial port (Port1) on models EA1-S6ML or EA1-S6MLW to connect with the CLICK, DL05, DL06, DL105, DL205, D3-350 and DL405 CPUs, your cabling choices are fairly simple.

- DV-1000CBL — connects to CLICK, DL05, DL06, DL105, DL205, D3-350 and D4-450 phone jack.
- D4-1000CBL — connects to all DL405 CPU 15-pin ports.

A maximum cable length of **10 feet** between the EA1-S6ML or EA1-S6MLW and the PLC is recommended when powering the panel in Low-Power Mode from the PLC. The EA-T6CL cannot be powered from a PLC.

The **C-more 6"** Micro-Graphic panels can communicate through its built-in 15-pin serial port (Port2) via RS-232, RS-422 and RS-485 using these cables.

- EA-2CBL — connects to CLICK, DL05, DL105, DL205, D3-350 and D4-450 phone jack.
- EA-2CBL-1 — connects to D2-250, D250-1, D2-260, DL06 VGA connector.

The EA1-T6CL can only communicate to a controller through the 15-pin serial Port2.

## Supported protocols

- AutomationDirect CLICK (Modbus)
- **Direct**LOGIC K-sequence
- **Direct**NET
- Modbus (Koyo Addressing)
- Modbus RTU
- Entivity Modbus RTU
- Allen-Bradley DF1 Half Duplex
- Allen-Bradley DF1 Full Duplex
- Allen-Bradley PLC5 DF1
- Allen-Bradley DH485
- GE Fanuc SNPX (90/30, 90/70, Micro 90, VersaMax Micro)
- Omron Host Link (C200 Adapter, C500)
- Omron FINS Serial (CJ1, CS1)
- Mitsubishi Melsec FX
- Mitsubishi Q and QnA
- Siemens PPI

## C-more 6" STN Micro-Graphic Port 1 to CLICK PLC Port 2

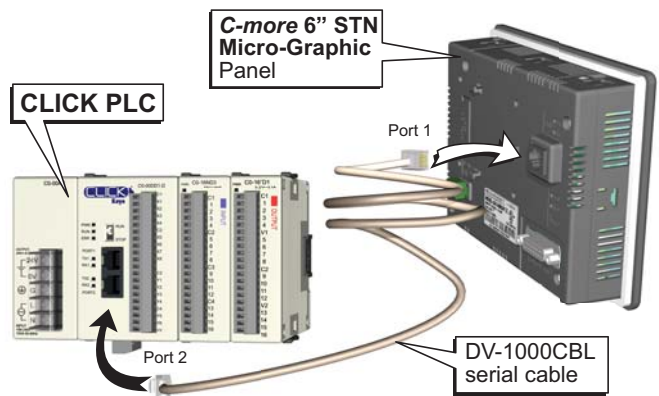

## C-more 6" Micro-Graphic Port 2 to DL06 PLC Port 2

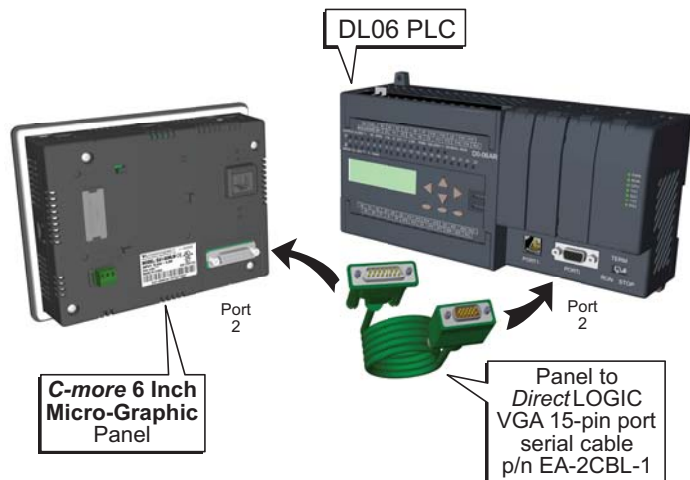

## Communication Ports

### EA1-S6ML & EA1-S6MLW

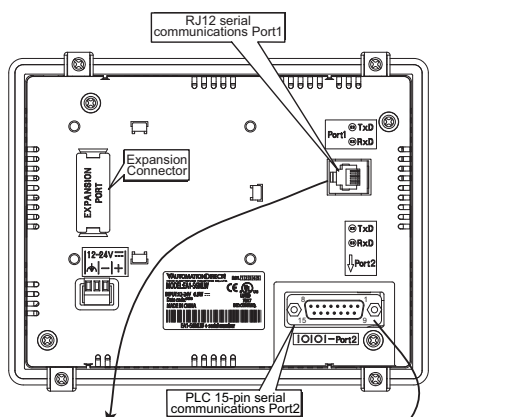

Pin	Signal
1	Logic GND
2	not used
3	RXD (232C)
4	TXD (232C)
5	+5 VDC
6	Logic GND

RS-232

Pin	Signal	Pin	Signal	Pin	Signal
1	Frame GND	6	LE	11	TXD+ (422/485)
2	TXD (232C)	7	CTS (232C)	12	TXD- (422/485)
3	RXD (232C)	8	RTS (232C)	13	Term. Resistor
4	Future	9	RXD+ (422/485)	14	do not use
5	Logic GND	10	RXD- (422/485)	15	do not use

RS-232/422/485

### EA1-T6CL

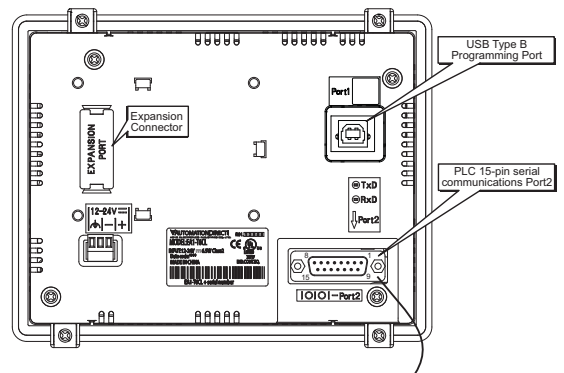

Pin	Signal	Pin	Signal	Pin	Signal
1	Frame GND	6	LE	11	TXD+ (422/485)
2	TXD (232C)	7	CTS (232C)	12	TXD- (422/485)
3	RXD (232C)	8	RTS (232C)	13	Term. Resistor
4	Future	9	RXD+ (422/485)	14	do not use
5	Logic GND	10	RXD- (422/485)	15	do not use

RS-232/422/485



# C-more 6" Micro-Graphic Communication Protocols & Cabling Chart

Controller Compatibility & Connection Chart							
PLC			C-more 6" Micro-Graphic Panel				
Family	CPU	PLC Port & Type	Panel to PLC Cabling Components Required for Specific Port and Protocol being used.				
			**PLC Port Powered or External DC Power Supply		External DC Power Supply		
			Using panel's RJ12 Port1		Using panel's Port2 DB 15-pin - female		
			Protocol(s) Supported	Components & Network Type	Protocol(s) Supported	Components & Network Type	
<b>CLICK</b>	all versions	Port 1 RJ12 - 6 pin	AutomationDirect Modbus (CLICK)	DV-1000CBL** RS-232	AutomationDirect Modbus (CLICK)	EA-2CBL RS-232	
<b>DirectLOGIC DL05</b>	all versions	Port 1 RJ12 - 6 pin	K-sequence, <i>Direct</i> NET, Modbus RTU	DV-1000CBL** RS-232	K-sequence, <i>Direct</i> NET, Modbus RTU	EA-2CBL RS-232	
		Port 2 RJ12 - 6 pin					
	D0-DCM	Port 2 DB15HD (female)	K-sequence, <i>Direct</i> NET, Modbus RTU	DV-1000CBL** RS-232	K-sequence, <i>Direct</i> NET, Modbus RTU	EA-2CBL RS-232	
		* See Note RS-422					
<b>DirectLOGIC DL06</b>	all versions	Port 1 RJ12 - 6 pin	K-sequence, <i>Direct</i> NET, Modbus RTU	DV-1000CBL** RS-232	K-sequence, <i>Direct</i> NET, Modbus RTU	EA-2CBL RS-232	
		Port 2 DB15HD (female)				EA-2CBL-1 RS-232	
			Modbus RTU	* See Note RS-485 Modbus only			
	D0-DCM	Port 1 RJ12 - 6 pin	K-sequence, <i>Direct</i> NET, Modbus RTU	DV-1000CBL** RS-232	K-sequence, <i>Direct</i> NET, Modbus RTU	EA-2CBL RS-232	
	Port 2 DB15HD (female)	EA-2CBL-1 RS-232					
		Modbus RTU	* See Note RS-422				
		Modbus RTU	* See Note RS-485 Modbus only				
<b>DirectLOGIC DL105</b>	all versions	Port 1 RJ12 - 6 pin	K-sequence	DV-1000CBL** RS-232	K-sequence	EA-2CBL RS-232	
<b>DirectLOGIC DL205</b>	D2-230	Port 1 RJ12 - 6 pin	K-sequence	DV-1000CBL** RS-232	K-sequence	EA-2CBL RS-232	
	D2-240	Port 1 RJ12 - 6 pin	K-sequence	DV-1000CBL** RS-232	K-sequence	EA-2CBL RS-232	
		Port 2 RJ12 - 6 pin	K-sequence, <i>Direct</i> NET,		K-sequence, <i>Direct</i> NET,		
	D2-250-1	D2-250-1	K-sequence, <i>Direct</i> NET, Modbus RTU	K-sequence, <i>Direct</i> NET, Modbus RTU	DV-1000CBL** RS-232	K-sequence, <i>Direct</i> NET, Modbus RTU	EA-2CBL RS-232
		Port 2 DB15HD (female)			DV-1000CBL** RS-232 + FA-15HD RS-232	EA-2CBL-1 RS-232	
			* See Note RS-422				
	D2-260	Port 1 RJ12 - 6 pin	K-sequence, <i>Direct</i> NET, Modbus RTU	K-sequence, <i>Direct</i> NET, Modbus RTU	DV-1000CBL** RS-232	K-sequence, <i>Direct</i> NET, Modbus RTU	EA-2CBL RS-232
		Port 2 DB15HD (female)			DV-1000CBL RS-232 + FA-15HD RS-232	EA-2CBL-1 RS-232	
		Modbus RTU	* See Note RS-422				
		Modbus RTU	* See Note RS-485 Modbus only				
D2-DCM	Port 1 DB 25 pin (female)	K-sequence, <i>Direct</i> NET, Modbus RTU	See Note RS-232	<i>Direct</i> NET	EA-4CBL-2 RS-232		
					* See Note RS-422		
WINPLC	Port 1 RJ12 - 6 pin	Modbus RTU	Modbus RTU	DV-1000CBL** RS-232	Modbus RTU	EA-2CBL RS-232	

\* Note: See the C-more 6" Micro-Graphic Hardware User Manual (P/N: EA1-MG6-USER-M), Chapter 6: PLC Communications, for wiring diagrams that the user can use to construct their own cables. The manual is available for download at [www.automationdirect.com](http://www.automationdirect.com).

\*\* Note: For EA1-S6ML and EA1-S6MLW, the PLC can provide 5 VDC through this cable. No external 12-24 VDC source is required, however, screen brightness is diminished and the alarm beep will not function. Low-Power Mode should be used during initial programming only. Connect an external 12-24 VDC power source when the panel is installed in its application. EA1-T6CL requires an external power supply.  
PLC Compatibility & Connection Chart continued on next page.

# C-more 6" Micro-Graphic Communication Protocols & Cabling Chart (cont'd)

Controller Compatibility & Connection Chart							
PLC			C-more 6" Micro-Graphic Panel				
Family	CPU	Port & Type	Panel to PLC Cabling Components Required for Specific Port and Protocol being used.				
			**PLC Port Powered or External DC Power Supply		External DC Power Supply		
			Using panel's RJ12 port 1		Using adapter's serial Port 2 15-pin D-sub - female		
			Protocol(s) Supported	Components & Network Type	Protocol(s) Supported	Components & Network Type	
DirectLOGIC DL305	D3-330 or D3-340	D3-232-DCU DB 25 pin (female)	DirectNET	EA-4CBL-2 RS-232	DirectNET	EA-4CBL-2 RS-232	
		D3-422-DCU DB 25 pin (female)	Not Possible		DirectNET	*See Note RS-422	
	D3-340	Port 1 RJ11 - 4 pin	DirectNET	OP-3CBL-1** RS-232	DirectNET	EA-3CBL RS-232	
		Port 2 RJ11 - 4 pin	DirectNET, Modbus RTU		DirectNET, Modbus RTU		
	D3-350	Port 1 RJ12 - 6 pin	K-sequence, DirectNET	DV-1000CBL** RS-232	K-sequence, DirectNET	EA-2CBL RS-232	
		Port 2 DB 25 pin (female)	K-sequence, DirectNET, Modbus RTU	*See Note RS-232	K-sequence, DirectNET, Modbus RTU	EA-4CBL-2 RS-232 *See Note RS-422	
	D3-DCM D3-350 only	Port 1 DB 25 pin (female)	K-sequence, DirectNET, Modbus RTU	*See Note RS-232	DirectNET	EA-4CBL-2 RS-232	
						*See Note RS-422	
	DirectLOGIC DL405	D4-430	Port 0 DB 15 pin (female)	K-sequence	D4-1000CBL or DV-1000CBL** & FA-CABKIT RS-232	K-sequence	EA-4CBL-1 RS-232
			Port 1 DB 25 pin (female)	K-sequence, DirectNET	DV-1000CBL & FA-CABKIT RS-232	K-sequence, DirectNET	EA-4CBL-2 RS-232 *See Note RS-422
D4-440		Port 0 DB 15 pin (female)	K-sequence	D4-1000CBL or DV-1000CBL** & FA-CABKIT RS-232	K-sequence	EA-4CBL-1 RS-232	
		Port 1 DB 25 pin (female)	K-sequence, DirectNET	DV-1000CBL** & FA-CABKIT RS-232	K-sequence, DirectNET	EA-4CBL-2 RS-232 *See Note RS-422	
D4-450		Port 0 DB 15 pin (female)	K-sequence	D4-1000CBL or DV-1000CBL** & FA-CABKIT RS-232	K-sequence	EA-4CBL-1 RS-232	
		Port 1 DB 25 pin (female)	K-sequence, DirectNET, Modbus RTU	DV-1000CBL** & FA-CABKIT RS-232	K-sequence, DirectNET, Modbus RTU	EA-4CBL-2 RS-232 *See Note RS-422	
		Port 3 DB 25 pin (female)	Not Possible		K-sequence, DirectNET, Modbus RTU	*See Note RS-422	
		Port 2 RJ12 - 6 pin	K-sequence, DirectNET	DV-1000CBL** RS-232	K-sequence, DirectNET	EA-2CBL RS-232	
D4-DCM		Port 1 DB 25 pin (female)	K-sequence, DirectNET, Modbus RTU	*See Note RS-232	DirectNET	EA-4CBL-2 RS-232 *See Note RS-422	

\* Note: See the C-more 6" Micro-Graphic Hardware User Manual (P/N: EA1-MGG-USER-M), Chapter 6: PLC Communications, for wiring diagrams that the user can use to construct their own cables. The manual is available for download at [www.automationdirect.com](http://www.automationdirect.com).

\*\* Note: For EA1-S6ML and EA1-S6MLW, the PLC can provide 5 VDC through this cable. No external 12-24 VDC source is required, however, screen brightness is diminished and the alarm beep will not function. Low-Power Mode should be used during initial programming only. Connect an external 12-24 VDC power source when the panel is installed in its application. EA1-T6CL requires an external power supply. PLC Compatibility & Connection Chart continued on next page.

# C-more 6" Micro-Graphic Communication Protocols & Cabling Chart (cont'd)

Controller Compatibility & Connection Chart										
PLC			C-more Micro-Graphic Panel							
Family	CPU	Port & Type	Panel to PLC Cabling Components Required for Specific Port and Protocol being used.							
			PLC Port Powered Powered with 5 VDC from the connected PLC's comm. port.		DC Power Adapter Powered from an external 24 VDC source using the DC Power Adapter, EA-MG-P1.		Serial Port with DC Power Adapter Powered from an external 24 VDC source using the Serial Port with DC Power Adapter, EA-MG-SP1.			
			Using panel's RJ12 port 1		Using panel's RJ12 port 1		Using panel's RJ12 port 1		Using adapter's serial Port 2 15-pin D-sub - female	
			Protocol(s) Supported	Components & Network Type	Protocol(s) Supported	Components & Network Type	Protocol(s) Supported	Components & Network Type	Protocol(s) Supported	Components & Network Type
Allen-Bradley MicroLogix	1000, 1100, 1200, 1500	8-pin mini-din port	Not Possible	Not Possible	Not Possible	DF1 Full Duplex	EA-MLOGIX-CBL RS-232			
		RJ45 8-pin phone plug				DH485/AIC/AIC+	EA-DH485-CBL RS-232			
Allen-Bradley SLC500	5/03, 5/04, 5/05 5/01, 5/02, 5/03	9-pin D-sub port				DF1 Full Duplex	EA-SLC-232-CBL RS-232			
		RJ45 8-pin phone plug				DH485/AIC/AIC+	EA-DH485-CBL RS-232			
Allen-Bradley ControlLogix	all	9-pin D-sub port				DF1 Full Duplex	EA-SLC-232-CBL RS-232			
Allen-Bradley CompactLogix	all	9-pin D-sub port				DF1 Full Duplex	EA-SLC-232-CBL RS-232			
Allen-Bradley FlexLogix	all	9-pin D-sub port				DF1 Full Duplex	EA-SLC-232-CBL RS-232			
Allen-Bradley PLC5	all	25-pin D-sub port				DF1 Full Duplex	EA-PLC5-232-CBL RS-232			
		RJ45 8-pin phone plug				DH485/AIC/AIC+	EA-DH485-CBL RS-232			
GE	90/30, 90/70 Micro 90, VersaMax Micro	15-pin D-sub port				Not Possible	Not Possible	Not Possible	SNPX	EA-90-30-CBL RS-422
		RJ45 Port 1								See Note RS-232
15-pin D-sub port Port 2	EA-90-30-CBL RS-422									
Mitsubishi	Melsec FX Series Q / QnA	25-pin D-sub port	CPU Direct	EA-MITSU-CBL RS-422						
		8-pin mini-din port		EA-MITSU-CBL-1 RS-422						
		9-pin D-sub port		See Note RS-232						
Omron	C200 (Adapter), C500 CJ1, CS1, CQM1, CPM1, CPM2, C200	25-pin D-sub port	Host Link	EA-OMRON-CBL RS-232						
		9-pin D-sub port		FINS See Note RS-232						
Modicon	984 CPU, Quantum 113 CPU, AEG Modicon Micro Series 110 CPU	varies	Modbus RTU	See Note RS-232						
Siemens	S7-200 CPU	9-pin D-sub port 0 or 1	PPI	See Note RS-485						

Note: See the C-more Micro-Graphic Hardware User Manual, Chapter 6: PLC Communications, for wiring diagrams that the user can use to construct their own cables. The manual is available for download at [www.automationdirect.com](http://www.automationdirect.com). Available cables with descriptions shown on the next page.

# C-more 6" Micro-Graphic Communication Cables and Cable Kits

Cable Description	Cable Part Number	Price
<b>Cables for direct connect to panel's serial Port1 (Panel powered from PLC's serial port.)*</b>		
AutomationDirect CLICK, <i>Direct</i> LOGIC PLC RJ-12 port, DL05, DL06, DL105, DL205, D3-350, D4-450 & H2-WinPLC (RS-232C).	<b>DV-1000CBL</b>	<--->
<i>Direct</i> LOGIC DL405 PLC 15-pin D-sub port, DL405 (RS-232C).	<b>D4-1000CBL</b>	<--->
<i>Direct</i> LOGIC (VGA Style) 15-pin port, DL06, D2-250 (250-1), D2-260 (RS-232C). <b>Use with DV-1000CBL cable.</b>	<b>FA-15HD</b>	<--->
<i>Direct</i> LOGIC PLC 15-pin D-sub port, DL405 (RS-232C). <b>Use with DV-1000CBL cable.</b>	<b>FA-CABKIT</b>	<--->
<i>Direct</i> LOGIC PLC RJ-11 port, D3-340 (RS-232C).	<b>OP-3CBL-1</b>	<--->
<b>Cables used with serial Port2</b>		
AutomationDirect CLICK, <i>Direct</i> LOGIC PLC RJ-12 port, DL05, DL06, DL105, DL205, D3-350, D4-450 & H2-WinPLC (RS-232C).	<b>EA-2CBL</b>	<--->
<i>Direct</i> LOGIC (VGA Style) 15-pin port, DL06, D2-250 (250-1), D2-260 (RS-232C).	<b>EA-2CBL-1</b>	<--->
<i>Direct</i> LOGIC PLC RJ-11 port, D3-340 (RS-232C).	<b>EA-3CBL</b>	<--->
<i>Direct</i> LOGIC DL405 PLC 15-pin D-sub port, DL405 (RS-232C).	<b>EA-4CBL-1</b>	<--->
<i>Direct</i> LOGIC PLC 25-pin D-sub port, DL405, D3-350, DL305 DCU and all DCM's (RS-232C).	<b>EA-4CBL-2</b>	<--->
Allen-Bradley MicroLogix 1000, 1100, 1200 & 1500 (RS-232C)	<b>EA-MLOGIX-CBL</b>	<--->
Allen-Bradley SLC 5-03/04/05, ControlLogix, CompactLogix, FlexLogix DF1 port (RS-232C)	<b>EA-SLC-232-CBL</b>	<--->
Allen-Bradley PLC-5 DF1 port (RS-232C)	<b>EA-PLC5-232-CBL</b>	<--->
Allen-Bradley MicroLogix, SLC-5-01/02/03, PLC5 DH485 port (RS-232C)	<b>EA-DH485-CBL</b>	<--->
GE 90/30 and 90/70, Micro 90, VersaMax Micro (Port 2) 15-pin D-sub port (RS-422A)	<b>EA-90-30-CBL</b>	<--->
MITSUBISHI FX Series 25-pin port (RS-422A)	<b>EA-MITSU-CBL</b>	<--->
MITSUBISHI FX Series 8-pin mini-DIN (RS-422A)	<b>EA-MITSU-CBL-1</b>	<--->
OMRON Host Link C200 Adapter, C500 (RS-232C)	<b>EA-OMRON-CBL</b>	<--->



**\*NOTE: EA1-T6CL cannot be powered by a PLC and cannot communicate with a PLC through Port1**



Part No. DV-1000CBL



Part No. D4-1000CBL



Part No. OP-3CBL-1



Part No. FA-15HD



Part No. FA-CABKIT



Part No. EA-2CBL



Part No. EA-2CBL-1



Part No. EA-3CBL



Part No. EA-4CBL-1



Part No. EA-4CBL-2



Part No. EA-MLOGIX-CBL



Part No. EA-SLC-232-CBL



Part No. EA-PLC5-232-CBL



Part No. EA-DH485-CBL



Part No. EA-90-30-CBL



Part No. EA-MITSU-CBL



Part No. EA-MITSU-CBL-1



Part No. EA-OMRON-CBL

# C-more 6" Micro-Graphic Panel Accessories

## 20-Button Keypad Bezel, Landscape Orientation

The 20-button keypad bezel is designed to be used with all **C-more 6"** Micro-Graphic panels. The keypad includes four directional arrow cursor buttons, a full numeric keypad, and one each of an ESCAPE, MENU, CLEAR and ENTER button. The keypad is intended to be used with the numeric entry object (Style 3) to allow changing of a value, and can also be used to

navigate and select screen objects. The numeric buttons can be used to enter a new value, along with the ENTER and CLEAR buttons. The 6" panels mount directly into the bezel; no panel configuration is required.

### Part No. EA-MG6-BZ2



Four directional cursor buttons, numeric buttons and ESC, MENU, CLEAR and ENTER buttons.



### Dimensions

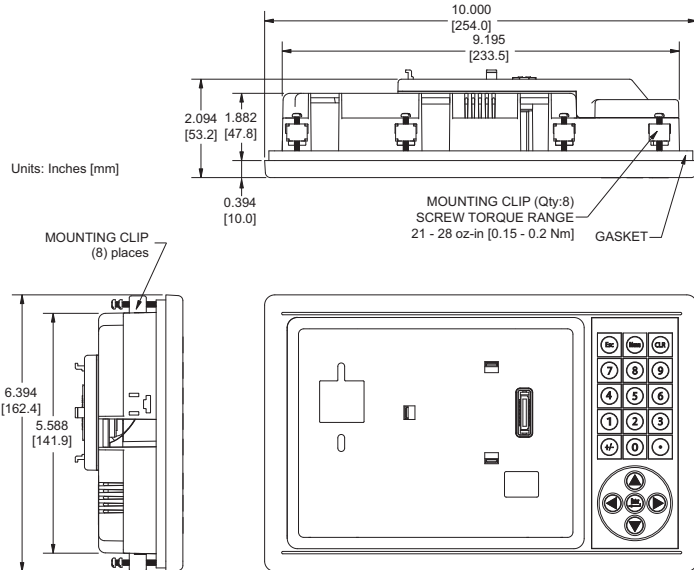

### Panel Cutout

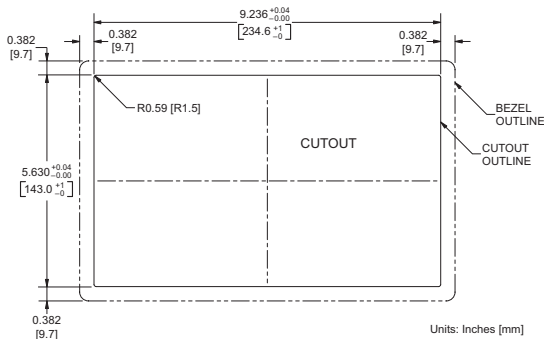

### Panel Thickness

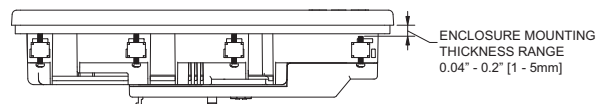

20-Button Keypad Bezel Specifications	
<b>Part Number</b>	EA-MG6-BZ2
<b>General</b>	
• <b>Micro-Graphic Panels Supported</b>	EA-S6ML, EA-S6MLW, EA1-T6CL
• <b>Connection</b>	Connects with expansion connector on the rear of the <b>C-more 6"</b> Micro-Graphic panel.
• <b>Power Consumption</b>	None
• <b>Keypad Button Life</b>	Minimum of 500,000 cycles
• <b>Enclosure Mounting</b>	(8) mounting clips, EA-MG-BZ2-BRK, included.
	Note: The <b>C-more 6"</b> Micro-Graphic panel is installed into the keypad bezel using the (4) mounting clips, EA-MG-BZ2-BRK, that are supplied with the panel.
<b>Physical</b>	
• <b>Dimensions</b>	10.000" (W) x 6.394" (H) x 2.488" (D) [254.0 mm x 162.4 mm x 63.2 mm]
• <b>Weight</b>	26.1 oz. [740 g]
<b>Environmental:</b>	See Micro-Graphic panel specifications at the beginning of this catalog section



# C-more Micro-Graphic Panel Accessories

## 21-Button Keypad Bezel, Portrait Orientation

The 21-button keypad bezel is designed to be used with all **C-more** 6" Micro-Graphic panels. The keypad includes four directional arrow cursor buttons, a full numeric keypad, and one each of an ESCAPE, MENU, CLEAR and two ENTER buttons. The keypad is intended to be used with the numeric entry object (Style 3) to allow changing of a value, and can also be used to

navigate & select screen objects. The numeric buttons can be used to enter a new value, along with the ENTER and CLEAR buttons. The 6" panels mount directly into the bezel; no panel configuration is required.

### Part No. EA-MG6-BZ2P



### Panel Cutout

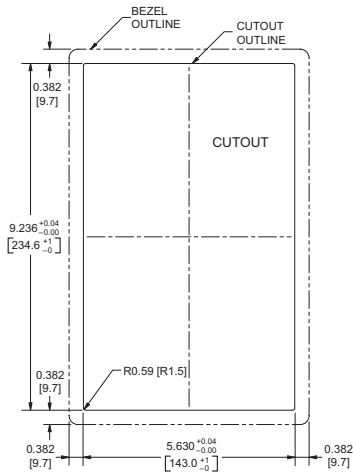

### Dimensions

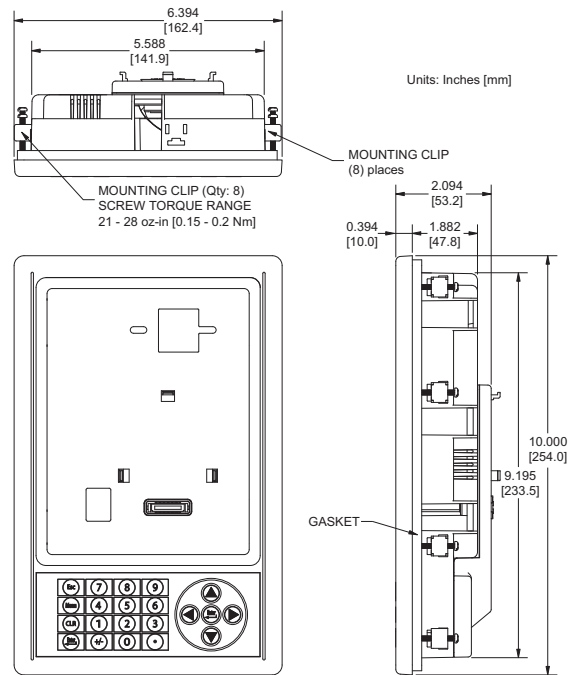

**Four directional cursor buttons, numeric buttons, and ESC, MENU, CLEAR and ENTER buttons.**

### Panel Thickness

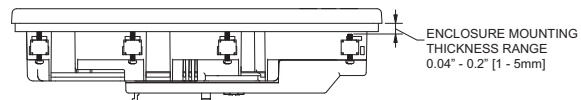

### 21-Button Keypad Bezel Specifications

Part Number	EA-MG6-BZ2P
<b>General</b>	
• <b>Micro-Graphic Panels Supported</b>	EA-S6ML, EA-S6MLW, EA1-T6CL
• <b>Connection</b>	Connects with expansion connector on the rear of the <b>C-more</b> 6" Micro-Graphic panel.
• <b>Power Consumption</b>	None
• <b>Keypad Button Life</b>	Minimum of 500,000 cycles
• <b>Enclosure Mounting</b>	(8) mounting clips, EA-MG-BZ2-BRK, included.
	Note: The <b>C-more</b> 6" Micro-Graphic panel is installed into the keypad bezel using the (4) mounting clips, EA-MG-BZ2-BRK, that are supplied with the panel.
<b>Physical</b>	
• <b>Dimensions</b>	6.394" (W) x 10.000" (H) x 2.488" (D) [162.4 mm x 254.0 mm x 63.2 mm]
• <b>Weight</b>	26.1 oz. [740 g]
<b>Environmental</b>	See Micro-Graphic panel specifications at the beginning of this catalog section

# C-more 6" Micro-Graphic Panel Accessories

## D-SUB 15-pin 90-degree Communication Port Adapter

The EA-ADPTR-4 adapter plugs into the 15-pin serial port on the rear of a 6" panel to allow a controller communication cable to be plugged in at a 90 degree angle to reduce panel depth requirements. UL Recognized.

**Part No.**  
**EA-ADPTR-4**



## Dimensions

Units: inches [mm]

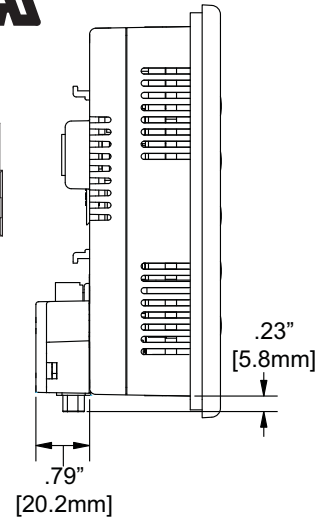
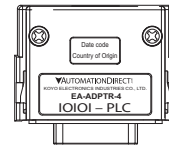
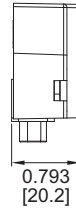
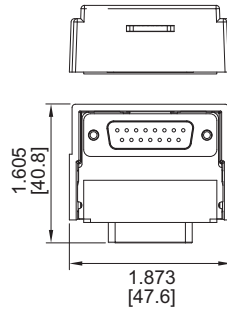

## D-SUB 15-pin to Terminal Block Adapter

The EA-COMCON-3 adapter plugs into the 15-pin serial port on the rear of a 6" panel to allow wire terminal connections for an RS-422/RS-485/DH-485 PLC communication cable. UL Recognized.

**Part No.**  
**EA-COMCON-3**



## Dimensions

Units: inches [mm]

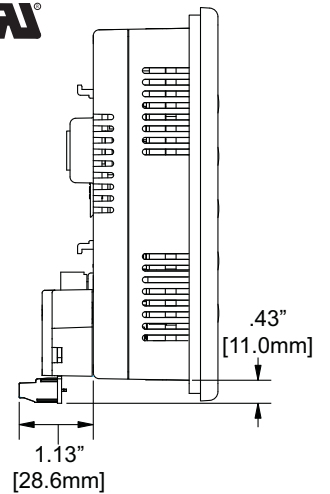
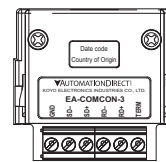
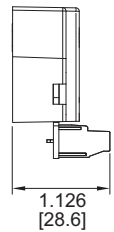
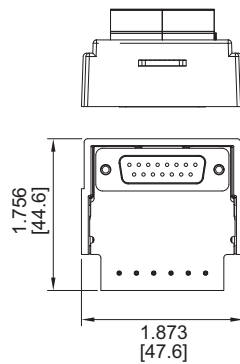

**Terminals**

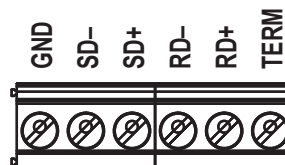

# C-more 6" Micro-Graphic Panel Accessories

## Clear Screen Overlay

Optional clear screen overlay used to protect C-more 6" Micro-Graphic displays from minor scratches and wear. Package contains 3 clear screen overlays.

Part No. EA-6-COV2

### Dimensions

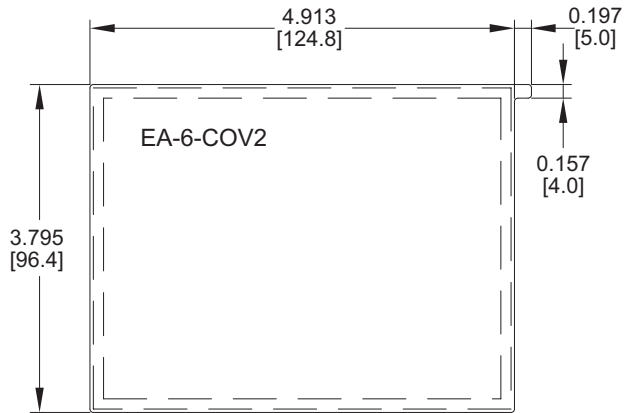
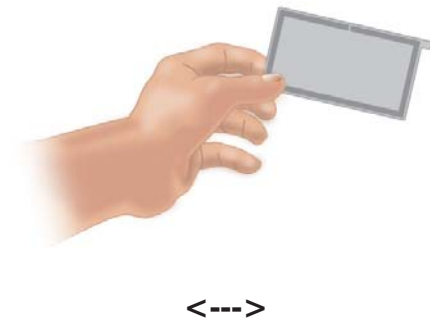

## Clear Screen Overlay Installation

Step 1



Remove the overlay from the package

Step 2



Remove the paper backing from the overlay

Step 3



Align the overlay with the screen and press the adhesive firmly into place

Step 4



Remove the protective film\*



\*Note: The overlay cover ships with a thin protective film on the face that should be carefully removed after installation.

# C-more 6" Micro-Graphic Replacement Parts

The optional replacement parts can be used to replace damaged, worn or lost C-more 6" Micro-Graphic panel components.

## Replacement parts at a glance:

Part Number	Description	Price
EA-MG-BZ2-BRK	Replacement mounting clip for <b>C-more</b> Micro-Graphic panel and keypad bezels. Also used to mount the <b>C-more</b> 3" Micro-Graphic bezel EA-MG-BZ2. (pk of 8)	<--->
EA-MG-DC-CON	Replacement adapter DC power connector (pk of 5)	<--->
EA-MG6-S6ML-GSK	Replacement mounting gasket for <b>C-more</b> 6" Micro-Graphic panels	<--->
EA-MG6-BZ2-GSK	Replacement mounting gasket for <b>C-more</b> 6" Micro-Graphic keypad bezels EA-MG6-BZ2 and EA-MG6-BZ2P	<--->
EA-MG6-S6ML-FKL	Replacement function key label insert for <b>C-more</b> 6" Micro-Graphic panels (pk of 5; 3 blank, 1 F1-F5 for landscape, 1 F1-F5 for portrait)	<--->

**Panel Mounting Clips**  
Part No. EA-MG-BZ2-BRK

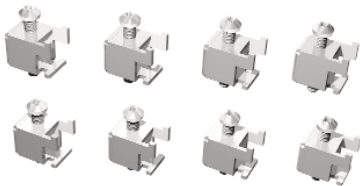

(pk of 8)

**DC Power Connector**  
Part No. EA-MG-DC-CON



(pk of 5)

**Function Keys Label Inserts**  
Part No. EA-MG6-S6ML-FKL



(pk of 5; 3 blank, 1 F1-F5 for landscape, 1 F1-F5 for portrait)

**Panel Gasket**  
Part No. EA-MG6-S6ML-GSK



**Keypad Bezel Gasket**  
Part No. EA-MG6-BZ2-GSK



# C-more Micro-Graphic Programming Software

## FREE software!

C-more Micro-Graphic Programming Software can be downloaded at no charge or a CD version may be purchased by ordering EA-MG-PGMSW. The software requires a USB port on your PC to connect to the C-more Micro-Graphic panel. Software Help Files are included in the download. This software programs all the C-more Micro-Graphic panels (does not program the C-more 6" through 15" touch panels).



**Note: This software is used to program C-more Micro-Graphic panels only.**  
**Part Numbers: EA1-S3ML, EA1-S3ML-N, EA1-S3MLW, EA1-S3MLW-N, EA1-S6ML, EA1-S6MLW, EA1-T6CL**



**NOTE: Software and Firmware Version 2.50 or later is required with model EA1-T6CL.**  
**Software and Firmware Version 2.0 or later is required with models EA1-S6ML and EA1-S6MLW.**  
**Software and Firmware Version 1.5 or later is required with models EA1-S3MLW and EA1-S3MLW-N.**  
**Available for free download at [www.automationdirect.com](http://www.automationdirect.com).**

C-more Micro-Graphic Programming Software is a spin-off of its powerful sibling C-more Touch Panel. It offers very high end features designed to reduce your configuration time. Simply drag and drop the objects from the object list (right side of screen) onto the screen construction area. Then configure your PLC tags and click on the objects you wish to use. Use the built-in simulator to review your work on your PC before ever downloading your project! The time saving benefits of the C-more Micro-Graphic configuration software could easily pay for the panel. Check out [www.CmoreMicro.com](http://www.CmoreMicro.com) to download a free version.

## Built-in project simulator

- Runs your project on your PC
- Test all of your screens before downloading
- Time savings pays for the panel
- Version 2.5 or later - Simulate function keys and keypad bezel.

## Built-in user object/screen libraries

Save time by re-using your custom objects and screens.

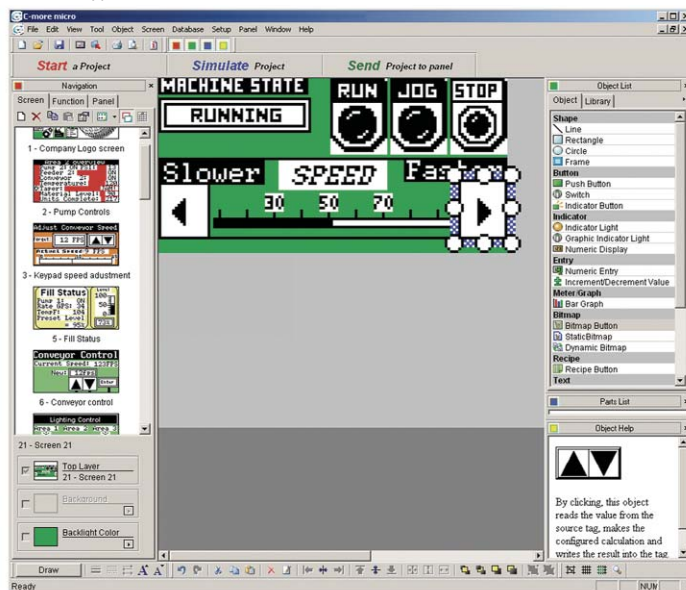

## Scrolling object selection window

Lets you find the object you want fast. Just drag and drop it on the screen.

## Thumbnail project preview pane

Helps keep track of multi-screen projects.

## PC requirements

Following are the minimum system requirements for running C-more Micro-Graphic Programming Software, EA-MG-PGMSW, on a PC:













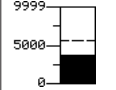











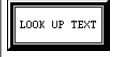

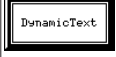
- Personal Computer with a 333 MHz or higher processor (CPU) clock speed recommended;
- Keyboard and Mouse or compatible pointing device
- Super VGA color video adapter and monitor with at least 800 x 600 pixels resolution (1024 x 768 pixels recommended) 64K color minimum
- 150 MB free hard-disk space
- 128 MB free RAM (512 MB recommended); 512 MB free RAM (1GB recommended) for Vista
- CD-ROM or DVD drive for installing software from the CD, or internet access to download free programming software
- USB port to use with an EA-MG-PGM-CBL, USB to RS232 Programming Cable Assembly for project transfer from the programming software to the panel
- Operating System - Windows® XP Home / Professional Edition Service Pack 2, Windows® 2000 with Service Pack 4, or Windows® Vista

## Scrolling help window

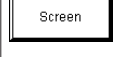
Gives you helpful information on each object

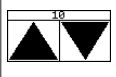

# C-more Micro-Graphic Programming Software

C-more Micro-Graphic Panel Objects			
Object	Graphic	Object	Graphic
The <b>Line</b> object, just like with drawing tools, allows the user to insert a straight line drawing into a project. When a Line is inserted into a project, a window opens to allow the user to setup all available parameters for the Line object. Some of the uses for Line Objects include but are not limited to adding callouts, pointers, or indicators.		The <b>Analog Meter</b> object is used to display the current value of a Tag Name.	
The <b>Rectangle</b> object, just like with drawing tools, allows the user to insert a drawing of a Rectangle as well as other geometric shapes into a project. When this object is inserted into a project, a window opens to allow the user to setup all available parameters for the Rectangle object.		The <b>Bar Meter</b> object is used to monitor up to two assigned Tag Names continuously. This object has various appearances depending upon the relative value of the tags. The Bar Meter can be used to create digital versions of level, current, and flow meters to name a few samples, or gauges that measure speed and other measurable data.	
The <b>Circle</b> object, just like with drawing tools, allows the user to insert a drawing of a Circle or ellipse shape into a project. When this object is inserted into a project, a window opens to allow the user to setup all available parameters for the Circle object.		The <b>Bitmap Button</b> object offers the ability to use a Bitmap graphic to perform the functions of a Button. This allows users to create their own graphics and implement them within the software project. The Bitmap Button object can be used to activate or deactivate components assigned to a Discrete Tag Name. The C-more Micro-Graphic display only supports two colors, black and white.	
The <b>Frame</b> object allows the user to insert a Frame to the project that can be used to Frame other objects. Some of the uses for Frame object include but are not limited to graphically separating objects for different operations that may appear on one screen and emphasizing pushbuttons or other objects that may require more attention by the operator.		The <b>Static Bitmap</b> offers the ability to display a Bitmap graphic on any screen. The Static Bitmap does not change state. Refer to the Dynamic Bitmap Object if you require the graphic object to change state based on a Tag Value in your PLC. The dialog box for a "Static Bitmap" object allows you to "read from disk" and select a graphic file for import. Graphics must be in one of the following formats: .BMP .WMF .JPG .JPEG	
The <b>Pushbutton</b> object is available from the Button Category of the Object List window. The Pushbutton object is an electronic version of a typical Pushbutton normally found on control panels. The Pushbutton object can be used to activate or deactivate components assigned to a Discrete Tag Name.		<b>Recipe</b> objects make it easy to make a large number of tag changes with the push of a single button. Create Recipes with up to 99 entries, and multiple sets of values. Then just push a button to load an entire set of values into the group of recipe tags.	
The <b>Switch</b> object is an electronic version of a typical Switch that normally can be found on control panels. The Switch object can be used to activate or deactivate components assigned to a Discrete Tag Name.		The <b>Dynamic Bitmap</b> object offers the ability to make an object using two different Bitmap graphics that will display one graphic when the Tag is On and a different graphic when the Tag is Off. Use your own bitmap designs or use some of the bitmaps provided with the software that are located in the User Graphic Library.	
The <b>Indicator Button</b> object is available from the Button Category of the Object List window. The Indicator Button object is an electronic version of a typical Indicator Button normally found on control panels. The Indicator Button is a combination of a Pushbutton and an Indicator Light. The Indicator Button can be used to activate or deactivate components assigned to a Discrete Tag Name.		The <b>Static Text</b> object is used to display a Frame with a personalized Message. This Frame and Message can be placed on any screen and any location within the screen.	
The <b>Indicator Light</b> object is an electronic version of a typical Indicator Light normally found on industrial control panels. The Indicator Light can be configured to display the status of the assigned Discrete Tag Name.		The <b>Lookup Text</b> object is used to display a Frame with a personalized Message. This Frame and Message can be placed on any screen and any location within the screen. The object is always displayed like a sign but is configured to display only the message prompted by an assigned Tag Name. Messages are retrieved from a Message Database which is configured by the user with text defined by the user. The Lookup Text Object will scroll text up to 128 characters.	
The <b>Graphic Indicator Light</b> object is a more enhanced version of the "Indicator Light Object" that allows the user to choose more detailed graphics to display the status of a tag. This object is an electronic version of a typical Indicator Light normally found on industrial control panels. The Indicator Light can be configured to display the status of the assigned Discrete Tag Name.		The <b>Dynamic Text</b> object is used to display text that is retrieved from data stored in a Tag. The Tag Name is assigned to registers in the PLC that contain set character data. The data can be stored in the PLC in ASCII format and may include information such as machine numbers, locations, part numbers, and such. The Message can be configured to be visible (Trigger) when an associated Tag Name is On or Off. This object can be placed on any screen and any location within the screen. The Dynamic Text Object will scroll text up to 40 characters.	
The <b>Numeric Display</b> consists of a frame that displays a real-time numeric value according to the value of data received from an assigned Tag Name. The Numeric Display supports numeric Signed Decimal, Unsigned Decimal, BCD, and Floating Point data types with up to 11 digits, including decimal point. User Defined Alpha Numeric Prefix and Suffix values are also supported.		The <b>Scroll Text</b> object is available from the Text Category of the Object List window. The Scroll Text object is an electronic version of a marquee. It is similar to the Static Text Object. If the text in the object does not fit in the window, it will scroll from right to left across the window. The Scroll Text object does not require a Tag Name assignment. The Scroll Text Object has a maximum character limit of 128 characters.	
The <b>Numeric Entry</b> object is used to enter a value from your Panel to a PLC Register. This object, when selected, opens a Numeric Keypad that allows the user to enter a new value that will be written to the assigned Tag Name. The Numeric Entry supports numeric Signed Decimal, Unsigned Decimal, BCD, and Floating Point data types with up to 11 digits, including decimal points. User Defined Alpha Numeric Prefix and Suffix values are also supported.		The <b>Screen Change</b> Pushbutton object is available from the Control Category of the Object List window. The Screen Change Pushbutton object is a pushbutton that can be configured to activate another screen in the project. This object may be edited to various colors and sizes. Users can configure the button to activate the Power-Up screen, Forward Screen, Previous Screen, or any one of the project screens.	
The <b>Increment/Decrement Value</b> object is used to add or subtract a value by pressing a button on the Panel. Basically the object uses two Tags, one to read a value from and another to write a modified value to. The Increment/Decrement Value supports numeric Signed Decimal, Unsigned Decimal, BCD, and Floating Point data types with up to 11 digits, including decimal points. The Increment and decrement values are also user selectable.		The <b>Screen Selector</b> object is available from the Control Category of the Object List window. This object is an enhanced version of the Screen Change pushbutton in that it offers many more features and defaults with data from screens in the project. This helps to save time by not having to create Screen change buttons for each screen. This object may be edited to various colors and sizes.	
The <b>Real Time Graph</b> object displays the value stored in up to two PLC tags, over a history of up to 24 points each. One point is added at each refresh.		The <b>Adjust Display Contrast</b> object is used to allow the operator to adjust the Panel Display Contrast. The default Display setting often works in most applications, however lighting may vary based on the location of each application. In these cases the operator can use this object to make adjustments. The current display setting value will appear on the top of the button and will change as the arrow keys are pressed. This button can be modified to various sizes.	
The <b>Line Graph</b> object displays the values of up to 24 PLC address points. Up to two address arrays can be displayed. The line is drawn in its entirety at each refresh.		The <b>Function</b> object is used to assign the panels function key buttons to a particular action as well as assigning the control of the LED On/Off status. When a button has been assigned as a shift button, the then F1 through F5 will become F6 through F10. The Function Object buttons will activate when the hardware button is pressed or when the object is pressed on the screen. The object size is restricted so that the keys will line up with the hardware function keys on the panel.	

# C-more STN Micro-Graphic Programming Connections

Using the **C-more** Micro-Graphic Programming Software for project development, STN **C-more** Micro-Graphic panels can be connected to a PC (personal computer) by using EA-MG-PGM-CBL, the USB-to-RS-232 cable assembly.

- Connect the USB programming cable (included) from a USB port type A on the PC to the USB type B port on the converter (included). Next connect the serial programming cable from the converter's RJ12 port to the panel's RJ12 serial port. The panel receives power from the USB port of the PC that it is connected to through the USB to RS-232 converter assembly.

## USB to RS-232 Programming Cable Assembly

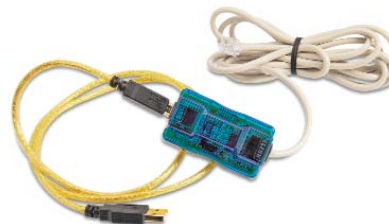

Part No. EA-MG-PGM-CBL



### USB Connectivity

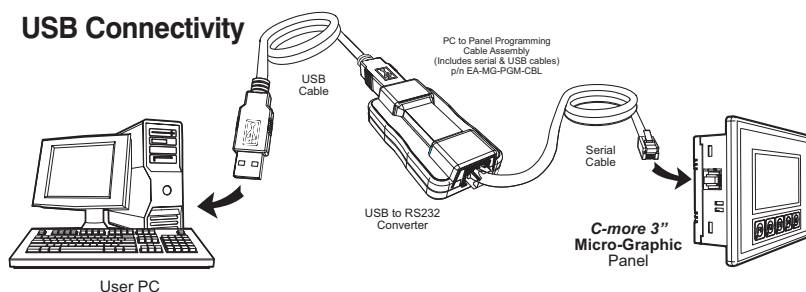

User PC



**NOTE: The TFT panel EA1-T6CL does NOT use the EA-MG-PGM-CBL assembly. The TFT panel EA1-T6CL uses a standard USB A-to-B type cable such as USB-CBL-AB6.**

### USB to RS-232 Converter Specifications

Part Number	EA-MG-PGM-CBL
<b>Hardware</b>	
<b>USB Interface</b>	USB Specification Rev. 1.1 Connector: USB Type B jack to accept USB Type B cable plug
<b>Serial Interface</b>	RS-232 (EIA-232-E) Connector: RJ12 phone jack 6p to accept RJ12 cable plug
<b>Baud Rate</b>	115.2 kbps Maximum
<b>Input Voltage</b>	5 VDC (Supplied thru serial interface cable.)
<b>Power Consumption</b>	50 mA (Does not include power to panel and/or bezel.)
<b>Accessory Cables (included)</b>	
<b>USB Cable</b>	USB Type A plug to PC on one end, USB Type B plug to converter on other end, 0.30 m [1 foot] length (* Note)
<b>Serial Cable</b>	RJ12 phone plug connectors on both ends, 2.0 m [6.56 feet] length (* Note)
<b>Physical</b>	
<b>Dimensions</b>	2.559" (W) x 1.417" (H) x 0.886" (D) [65.0 mm x 36.0 mm x 22.5 mm]
<b>Weight</b>	1.06 oz. [30 g]
<b>Environmental</b>	See Micro-Graphic panel specifications at the beginning of this catalog section.
<b>* Note: Maximum cable length for either the USB or serial cable should not exceed 2.0 m [6.56 feet] in length.</b>	

## C-more TFT Micro-Graphic Programming Connection

The C-more TFT Micro-Graphic panel EA1-T6CL includes an integral USB to serial converter. It is programmed via any USB Type A to Type B cable.

When properly installed on your PC, the device driver will be assigned a communication port number and appear in Windows Device Manager as a serial com port.

### USB cable options for programming EA1-T6CL

Part Number	Description	Price
<b>USB-CBL-AB3</b>	Standard 3-ft. (0.9 m) USB 2.0 cable, A-type connector to B-type connector, used to connect personal computer to any <b>C-more</b> touch panel for setup and programming. (Note: Touch panels require a 24 VDC power source for configuration and operation.)	<--->
<b>USB-CBL-AB6</b>	Standard 6-ft. (1.8 m) USB 2.0 cable, A-type connector to B-type connector, used to connect personal computer to any <b>C-more</b> touch panel for setup and programming. (Note: Touch panels require a 24 VDC power source for configuration and operation.)	<--->
<b>USB-CBL-AB10</b>	Standard 10-ft (3 meter) USB 2.0 cable, A-type connector to B-type connector, used to connect personal computer to any <b>C-more</b> touch panel for setup and programming. (Note: Touch panels require a 24 VDC power source for configuration and operation.)	<--->
<b>USB-CBL-AB15</b>	Standard 15-ft. (4.6 m) USB 2.0 cable, A-type connector to B-type connector, used to connect personal computer to any <b>C-more</b> touch panel for setup and programming. (Note: Touch panels require a 24 VDC power source for configuration and operation.)	<--->