

AC Input and AC/DC Input Modules

D3-16NA AC Input <---->	
Inputs per Module	16
Commons per Module	2 (isolated)
Input Voltage Range	80-132VAC
Input Voltage Supply	External
Peak Voltage	132VAC
AC Frequency	50-60Hz
ON Voltage Level	>80 VAC
OFF Voltage Level	<15 VAC
Input Impedance	8 K ohm
Input Current	16mA @ 60Hz 24mA @ 60 Hz
Minimum ON Current	8mA
Maximum OFF Current	1.5mA
Base Power Required*	9V 6.25mA max/ON pt 100 mA max
OFF to ON Response	5-50ms
ON to OFF Response	5-60ms
Terminal Types	Removable
Status Indicators	Logic side
Weight	6.4oz. (189g)

*9V typical values are 4mA/ON pt., 64mA total

D3-08NE3 AC/DC Input <---->	
Inputs per Module	8 (sink/source)
Commons per Module	2 (isolated)
Input Voltage Range	20-28VAC/VDC
Input Voltage	External
Peak Voltage	28VAC/VDC
AC Frequency	47-63Hz
ON Voltage Level	>20V
OFF Voltage Level	<6V
Input Impedance	1.5Kohm
Input Current	19mA max
Minimum ON Current	10mA
Maximum OFF Current	2mA
Base Power Required	9V 10mA max 24V N/A
OFF to ON Response	AC: 5-50ms DC: 6-30ms
ON to OFF Response	AC/DC: 5-60ms
Terminal Type	Non-removable
Status Indicators	Field side
Weight	4.2oz. (120g)

See page 5-29 for part numbers of ZIPLink cables and connection modules compatible with this I/O module.

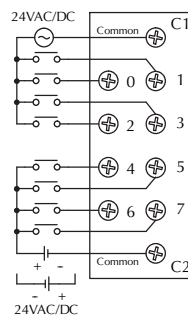
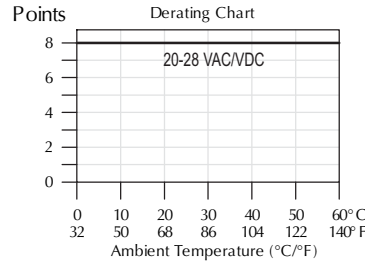
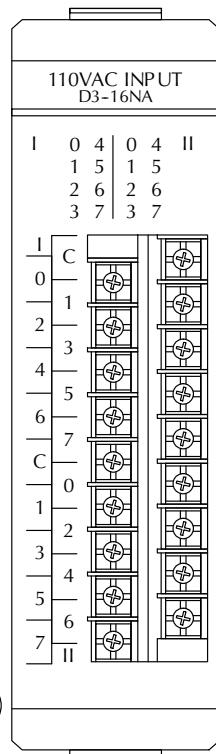
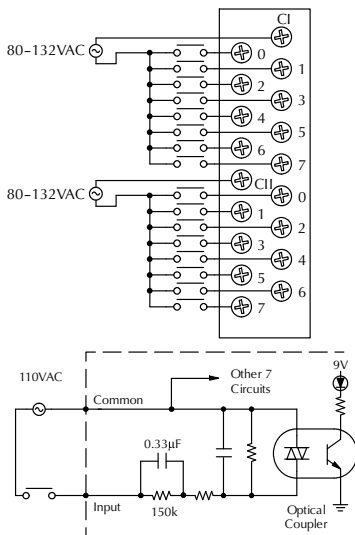
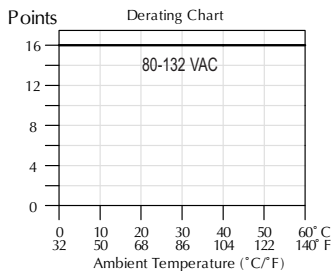

NOTE: This module can be wired in a sourcing configuration and it will be operational except there will be no module LED indication for each input.

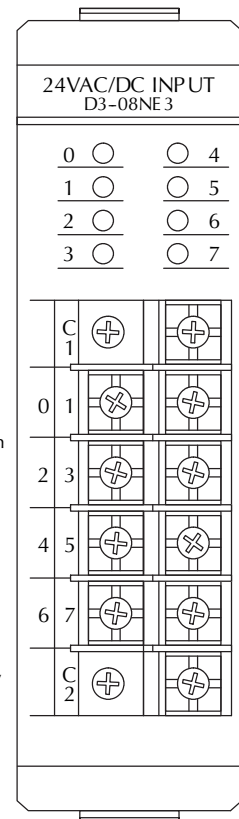
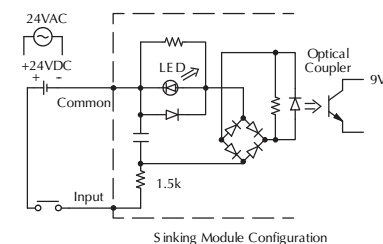

Power Budget

Managing your power resource

The I/O configuration depends on your choice of I/O modules, bases and I/O location. When determining the types and quantity of I/O modules you will be using, it's important to remember there is a limited amount of power available from the power supply.

The chart on the next page indicates the power supplied and used by each DL305 device. The adjacent chart shows an example of how to calculate the power used by your particular system. These two charts should make it easy for you to determine if the devices you have chosen fit within the power budget of your system configuration.

If the I/O you have chosen exceeds the maximum power available from the power supply, you can resolve the problem by shifting some of the modules to an expansion base.

WARNING: It is extremely important to calculate the power budget correctly. If you exceed the power budget, the system may operate in an unpredictable manner, which may result in a risk of personal injury or equipment damage.

Example: how to calculate your power usage

The following example shows how to calculate the power budget for the DL305 system. The examples are constructed around a single 5-slot base using the devices shown. It is recommended you construct a similar table for each base in your DL305 system.

1. Using a chart similar to the one below, fill in column 2.
2. Using the tables on the opposite page, enter the current supplied and used by each device (columns 3, 4, and 5). Devices which fall into the "Other" category (Row D) are devices such as the Handheld Programmer or a Data Communication Unit, which also have power requirements, but do not directly plug into the base.

3. Add the current used by the system devices (columns 3, 4, and 5), starting with Slot 1, then put the total in the row labeled "Maximum Current Required" (Row E).
4. Subtract the row labeled "Maximum Current Required" (Row E), from the row labeled "Current Supplied" (Row B). Place the difference in the row labeled "Remaining Current" (Row F).
5. If "Maximum Current Required" is greater than "Current Supplied" in columns 3, 4 or 5, the power budget will be exceeded. It will be unsafe to use this configuration and you will need to restructure your I/O configuration.

Use ZIPLinks to reduce power requirements

If your application requires a lot of relay outputs, consider using the ZipLink AC or DC relay output modules. These modules can switch high current (10A) loads without putting a load on your base power budget. Refer to the Wiring Solutions section in this catalog for more information.

This logo is placed next to I/O modules that are supported by the ZIPLink connection systems. See the I/O module specifications at the end of this section.



A	Column 1	Column 2	Column 3	Column 4	Column 5
Base # 0	Device Type		5 VDC (mA)	9VDC (mA)	24V(mA)
B	Current Supplied				
	5-slot Base	D3-05BDC	1400	800	500
C	Current Required				
	CPU Slot	D3-330	300	50	0
	Slot 0	D3-16NE3	0	130	0
	Slot 1	D3-16NE3	0	130	0
	Slot 2	D3-08TA-1	0	160	0
	Slot 3	D3-08TA-1	0	160	0
D	Other				
	Handheld prog D3-HPP		50	50	0
E	Maximum Current Required		360	680	0
F	Remaining Current		1040	120	500

DL305 Power Requirements

This section shows the amount of power supplied by the base power supplies and the amount of power used by each DL305 device. Note the base power supplies provide three internal voltages (5V, 9V, 24V). The chart shows how much power from each of these power sources is required for each DL305 device. Use this information when calculating the power budget for your system.

In addition to the three internal power sources, the DL305 bases provide an external power connection. There is 24 VDC available from the 24 VDC output terminals on the bases (except D3-05BDC and D3-10BDC).

The 24 VDC can be used to power external devices or DL305 modules that require external 24 VDC. The power used from this external 24 VDC output reduces the internal system 24 VDC that is available to the modules by an equal amount. When using the 24 VDC output at the base terminal, it is recommended that 100 mA not be exceeded.

Power Consumed				
Device	5V(mA)	9V(mA)	24V(mA)	Ext req.
CPUs				
D3-330	300	50	0	0
D3-340	300	20	0	0
D3-350	500	0	0	0
DC Input Modules				
D3-08ND2	0	10	112	0
D3-16ND2-1	0	25	224	0
D3-16ND2F	0	25	224	0
F3-16ND3F	0	148	68	0
AC Input Modules				
D3-08NA-1	0	10	0	0
D3-08NA-2	0	10	0	0
D3-16NA	0	100	0	0
AC/DC Input Modules				
D3-08NE3	0	10	0	0
D3-16NE3	0	130	0	0
DC Output Modules				
D3-04TD1	0	12	5	0
D3-08TD1	0	20	24	0
D3-08TD2	0	30	0	0
D3-16TD1-1	0	40	96	0
D3-16TD2	0	180	0	0
AC Output Modules				
D3-04TAS	0	12	0	0
F3-08TAS-1	0	200	0	0
D3-08TA-1	0	160	0	0
D3-08TA-2	0	160	0	0
F3-16TA-2	0	250	0	0
D3-16TA-2	0	400	0	0

Power Supplied				
Device	5V(mA)	9V(mA)	24V(mA)	24 V (mA)
D3-05B-1	900	2000	500	100
D3-08B-1	900	2000	500	100
D3-10B-1	900	2000	500	100
D3-05BDC	900	2000	500	None
D3-10BDC	900	2000	500	None
D3-05B-NR	900	2000	500	100
D3-08B-NR	900	2000	500	100
D3-10B-NR	900	2000	500	100
D3-05BDC-NR	900	2000	500	None
D3-10BDC-NR	900	2000	500	None
Power Consumed				
Device	5V(mA)	9V(mA)	24V(mA)	External required
Relay Output Modules				
D3-08TR	0	360	0	0
F3-08TRS-1	0	296	0	0
F3-08TRS-2	0	296	0	0
D3-16TR	0	480	0	0
Analog Temperature and Thermocouple Modules				
F3-04ADS	0	183	50	0
F3-08AD-1	0	45	55	0
F3-08THM-n	0	50	34	0
F3-16AD	0	55	65	0
F3-04DA-1	0	144	108	0
F3-04DAS	0	154	145	0
Communications and Networking				
D3-232 DCU	500	0	0	Optional 5V@500mA
D3-422 DCU	500	0	0	Optional 5V@500mA
FA-UNICON	0	0	0	24V or 5V@ 100mA
D3- DCM	0	300	0	0
Specialty Modules				
D3-08SIM	0	10	112	0
D3-HSC	0	70	0	0
D3-TCSU	40	5	0	0
Programming				
D3-HP	50	50	0	0
D3-HPP	50	50	0	0
D2-HP	200	0	0	0
Specialty CPUs				
F3-OMUX-1	409	0	0	0
F3-OMUX-2	262	0	150	0
F3-PMUX	455	0	0	0
F3-RTU	416	0	0	0
Operator Interface				
DV-1000	150	0	0	0
<i>C-more</i> Micro-Graphic	210	0	0	0



Wiring System for DL305 PLCs

AutomationDirect

Cut PLC wiring time to minutes instead of hours

The ZIPLink wiring system eliminates the normally tedious process of wiring PLC I/O to terminal blocks. Simply plug one end of a ZIPLink pre-wired terminal block cable into your I/O module and the other end into a ZIPLink connector module. It's that easy. ZIPLinks use half the space, at a fraction of the total cost of terminal blocks.

ZIPLinks are available in a variety of styles to suit your needs, including feedthrough, fused, relay and sensor/LED connector modules. ZIPLinks are available for most DL305 Series PLC discrete and analog input and output modules.

For complete information see ZIPLinks in the Terminal Blocks and Wiring Solutions section.

Specify your ZIPLink system

Use the Compatibility Matrix table below:

Step 1	Locate the I/O module part number.
Step 2	Locate Connector Module Type. (Feedthrough Module, Fuse Module, etc...)
Step 3	Select the cable length by replacing the # symbol with: Blank = 0.5m, -1 = 1.0m, -2 = 2.0m ¹
¹ Note: Cable part number denotes compatibility between Connector Module and I/O Modules.	



ZIPLink Wiring System Compatibility Matrix for DL305 PLCs					
Step 2: Connector Module Type		Feedthrough Modules	Fuse Modules	Relay Modules	Sensor Input Modules
Step 1: I/O Module	Number of Terminals	Step 3: Cables			
Inputs					
D3-08ND2*	10	ZL-RTB20	ZL-RFU20	ZL-RRL16-24	ZL-LTB16-24
D3-16ND2-1	18	ZL-D3-CBL18#			
D3-16ND2F	18	ZL-D3-CBL18#			
F3-16ND3F	18	ZL-D3-CBL18#			
D3-08NA-1*	10				
D3-08NA-2*	10				
D3-16NA	18	ZL-D3-CBL18#			
D3-08NE3*	10				
D3-16NE3	18	ZL-D3-CBL18#			ZL-D3-CBL18#
Outputs					
D3-04TD1*	10				
D3-08TD1*	10				
D3-08TD2*	10				
D3-16TD1-1	18	ZL-D3-CBL18#	ZL-D3-CBL18#	ZL-D3-CBL18#	
D3-16TD2	18	ZL-D3-CBL18#	ZL-D3-CBL18#		
D3-04TAS*	10				
F3-08TAS-1	18	ZL-D3-CBL18#			
D3-08TA-1	18	ZL-D3-CBL18#			
D3-08TA-2*	10				
F3-16TA-2	18	ZL-D3-CBL18#	ZL-D3-CBL18#		
D3-16TA-2	18	ZL-D3-CBL18#	ZL-D3-CBL18#		
D3-08TR*	10				
D3-16TR**	18	ZL-D3-CBL18#	ZL-D3-CBL18#		
F3-08TRS-1**	18	ZL-D3-CBL18#			
F3-08TRS-2**	18	ZL-D3-CBL18#			
Analog					
F3-04ADS	18	ZL-D3-CBL18#			
F3-08AD-1	18	ZL-D3-CBL18#			
F3-16AD	18	ZL-D3-CBL18#			
F3-04DA-1	18	ZL-D3-CBL18#			
F3-04DAS	18	ZL-D3-CBL18#			
F3-08THM-J***					
F3-08THM-K***					

* These I/O modules have non-removable terminal blocks which can be terminated using the ZL-CBL24-N cable and the ZL-RTB20 module of the ZIPLink wiring system.

** Caution: The D3-16TR, F3-08TRS-1 and F3-08TRS-2 relay outputs are derated not to exceed 2 Amps per point and 4 Amps per common when used with the ZIPLink wiring system.

*** The F3-08THM-J and F3-08THM-K modules are not supported by the ZIPLink wiring system. These modules require wire specific to the signal type.

ZIPLinks Connector Module and Cable specifications are located in Terminal Blocks and Wiring Section