

# DL105 I/O Specifications

## F1-130AD



### Wiring diagram and specifications

#### Power requirements

Voltage range	.....94-240 VAC (30 VA)
	.....100-240 VDC (30 W)

#### AC input specifications

Number of input points	.....10
Number of commons	.....3 (isolated)
Input voltage range	.....80-132 VAC
	.....90-150 VDC
Input current	.....6 mA @ 132 VAC
	.....6.8 mA @ 150 VDC
ON current/voltage level	.....> 4 mA / 80 VAC
	.....> 4 mA / 90 VDC
OFF current/voltage level	.....< 2 mA / 45 VAC
	.....< 2 mA / 60 VDC
OFF to ON response	.....< 8 ms
ON to OFF response	.....< 15 ms
Fuses	.....None

#### DC output specifications

Number of output points	.....8 (sinking)
Number of commons	.....3 (internally connected)
Output circuitry	.....MOSFET
Output voltage range	.....5-30 VDC
Peak voltage	.....60 VDC
ON voltage drop	.....0.45 VDC @ 0.5 A
Maximum current	.....0.5 A/point (Y0-Y1)
	.....1.0 A/point (Y2-Y7)
Maximum leakage current	.....15 µA at 30 VDC
Maximum inrush current	.....1.5 A for 10 ms (Y0-Y1)
	.....3 A for 10 ms (Y2-Y7)
Minimum load	.....None
OFF to ON response	.....Y0-Y1: 10 µs
	.....Y2-Y7: 3.5 µs
ON to OFF response	.....Y0-Y1: 70 µs
	.....Y2-Y7: 110 µs
External DC power required	.....10-30 VDC
	.....@ 30 mA + load current
Fuses	.....None (external recommended)

#### Auxiliary 24 VDC Output

Voltage range	.....21.6 - 26.4 VDC
Output	.....500 mA max., isolated
Ripple	.....less than 200 mV p - p

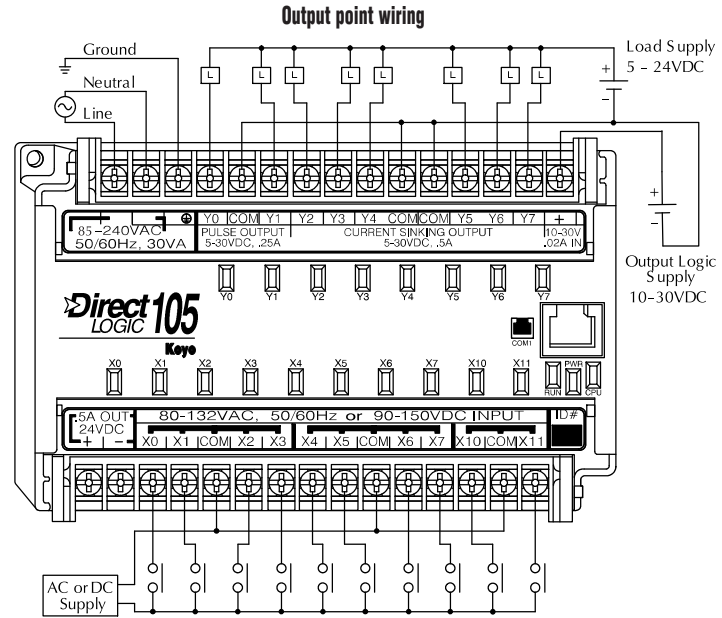

#### Input point wiring

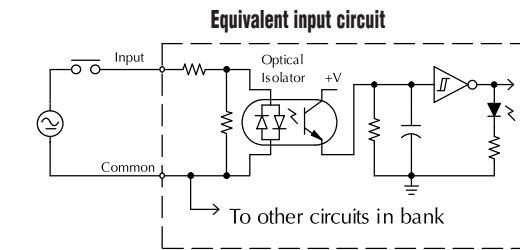

#### Equivalent output circuit

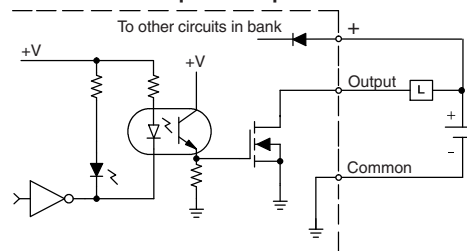

Derating chart for AC inputs

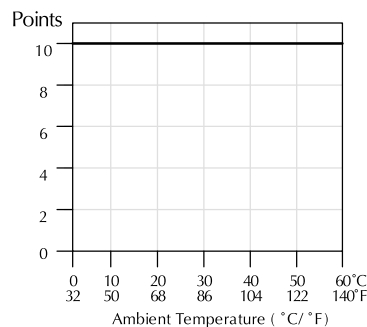

Derating chart for DC outputs

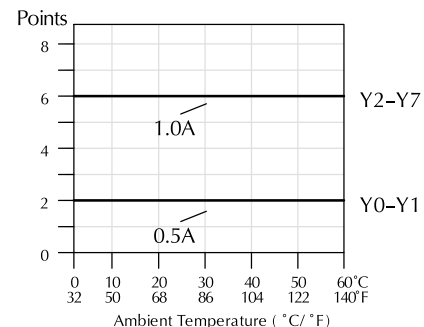

# Features and Specifications

The DL105 micro PLCs contain the CPU, power supply and I/O all in the same housing. If you examine the CPU Specifications table, you'll see that we included many features found in our modular CPUs.

## Review the specs

Make sure these features can satisfy the requirements of your application. Since these units are completely self-contained, you cannot expand the system or replace the CPU as you would in a modular system.

### System capacity

System capacity is the ability to accommodate a variety of applications. For ladder memory, most Boolean instructions require one word. Some other instructions, such as timers, counters, etc., require two or more words. Our V-memory words are useful for data storage, etc.

### Performance

The performance is simply the scan time, which is the amount of time required to read the inputs, solve the RLL program and update the outputs.

### Instructions and diagnostics

Make sure the unit offers the instructions you need.

### Communications

All DL105 units offer one RS-232 port, capable of 9,600 baud.

### Specialty features

For the DC input and/or DC output versions, we also offer several high-speed I/O features.

### AC-powered units

**F1-130AA**  
10 AC inputs, 8 AC outputs, 1.7 A/point

**F1-130AD**  
10 AC inputs, 8 DC outputs, 1.0 A/point, two outputs can be used as 7 kHz pulse output, 0.5 A/point

**F1-130AR**  
10 AC inputs, 8 relay outputs, 7 A/point

**F1-130DA**  
10 DC inputs, 4 inputs are filtered inputs, can also be configured as a single 5 kHz high-speed counter, interrupt input, or pulse catch input  
8 AC outputs, 1.7 A/point

**F1-130DD**  
10 DC inputs, 4 points are filtered inputs, can also be configured as a single 5 kHz high-speed counter, interrupt input, or pulse catch input  
8 DC outputs, 1.0 A/point, 2 outputs can be used as 7 kHz pulse output, 0.5 A/point

**F1-130DR**  
10 DC inputs, 4 inputs are filtered inputs, can also be configured as a single 5 kHz high-speed counter, interrupt input, or pulse catch input  
8 relay outputs, 7 A/point

### DC-powered units

**F1-130DD-D**  
10 DC inputs, 4 inputs can be used as 5 kHz high-speed counter, interrupt inputs, or pulse catch inputs  
8 DC outputs, 1.0 A/point, two outputs can be used as 7 kHz pulse output, 0.5 A/point.

**F1-130DR-D**  
10 DC inputs, 4 inputs can be used as 5 kHz high-speed counter, interrupt inputs, or pulse catch inputs  
8 relay outputs, 7 A/point

### Programming

Handheld programmer....D2-HPP.....<--->  
DirectSOFT Programming for Windows  
PC-DSOFT5 .....<--->  
PC-DS100 .....<--->  
PC-R50-U (upgrade).....<--->

*Note: Either high-speed input or pulse output can be used, but not in the same configuration.*

## DL105 CPU Specifications

### System capacity

Total memory available (words) ..... 2.4K  
Ladder memory (words) ..... 2,048 EEPROM  
V-memory (words) ..... 384  
User V ..... 256  
Non-volatile user V ..... 128  
Battery backup ..... No  
Total I/O ..... 18  
Inputs ..... 10  
Outputs ..... 8  
I/O expansion ..... No

### Performance

Contact execution (Boolean) ..... 3.3 us  
Typical scan (1K Boolean)<sup>1</sup> ..... 5-6 ms

### Instructions and diagnostics

RLL ladder style ..... Yes  
RLL<sup>plus</sup>/flowchart style (Stages) ..... Yes/256  
Run-time editing ..... Yes  
Supports Overrides ..... No  
Variable/fixed scan ..... Variable  
Instructions ..... 91  
Control relays ..... 256  
Timers ..... 64  
Counters ..... 64  
Immediate I/O ..... Yes  
Subroutines ..... No  
For/next loops ..... No  
Timed interrupt ..... Yes  
Integer math ..... Yes  
Floating-point math ..... No  
PID ..... No  
Drum sequencers ..... Yes  
Bit of word ..... No  
ASCII print ..... No  
Real-time clock/calendar ..... No  
Internal diagnostics ..... Yes  
Password security ..... Multi-level  
System and user error log ..... No

### Communications

Built-in ports ..... one, RS-232-C  
K-sequence (proprietary protocol) ..... Yes  
DirectNET<sup>TM</sup> ..... No  
MODBUS master/slave ..... No  
ASCII out ..... No  
Baud rate (fixed) ..... 9,600 baud

### Specialty features

Filtered inputs ..... Yes<sup>2</sup>  
Interrupt input ..... Yes<sup>2</sup>  
High-speed counter ..... Yes, 5 kHz<sup>2</sup>  
Pulse output ..... Yes, 7 kHz<sup>2</sup>  
Pulse catch input ..... Yes<sup>2</sup>

**1- Our 1K program includes contacts, coils, and scan overhead. If you compare our products to others, make sure you include their scan overhead.**

**2- Input features are only available on units with DC inputs. Output features are only available on units with DC outputs.**

# DL105 Hardware Features

## CPU status indicators

RUN	.....ON	.....	CPU is in RUN mode
	.....OFF	.....	CPU is in PROGRAM mode
PWR	.....ON	.....	CPU power good
	.....OFF	.....	CPU power failure
CPU	.....ON	.....	CPU internal diagnostics has detected an error
	.....OFF	.....	CPU is OK

## Mode control

The DL105 units do not have mode switches like many of our modular CPUs. You can set the unit (using special V-memory locations) so that it will power up in RUN mode.

## Communications port

Protocol	.....	K-sequence slave
Devices	.....	Can connect with HPP, DirectSOFT, DV-1000, C-More Panels
Specs	.....	6P6C RJ12 connector
	.....	RS-232-C, 9,600 baud,
	.....	Odd parity,
	.....	Fixed station address (1),
	.....	8 data bits (one start, one stop bit),
	.....	Asynchronous, half-duplex, DTE

### RJ12 Connector Port 1 Pinout

Pin	Signal
1	0V
2	5V
3	RS-232 Data in
4	RS-232 Data out
5	5V
6	0V

## Fixed EEPROM memory

The DL105 units offer built-in EEPROM memory.

**NOTE:** Terminals accept 16-24 AWG. For 16 AWG, use type TFFN or Type MTW. Other types of 16 AWG may be acceptable, but it really depends on the thickness of the wire insulation.

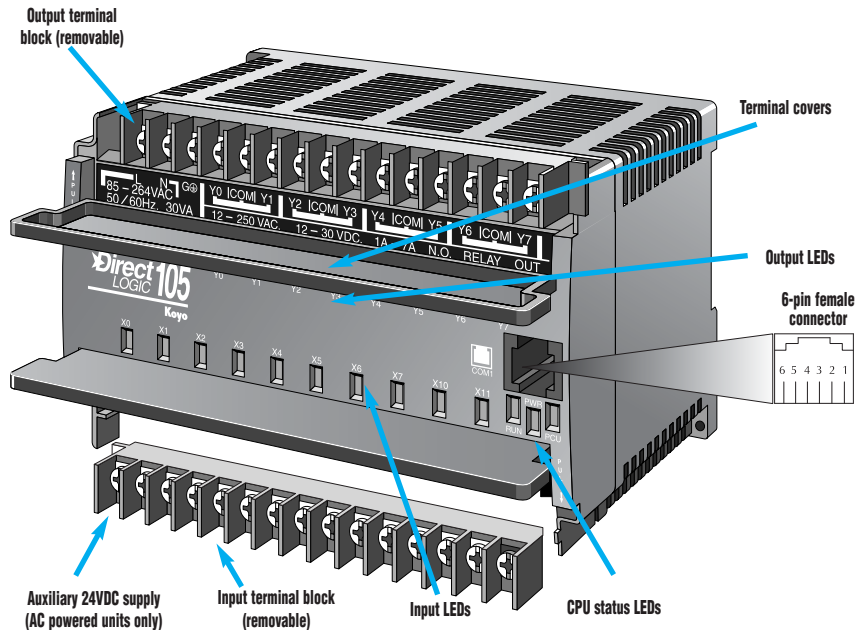

# Dimensions and Installation

It is important to understand the installation requirements for your DL105 system. This will help ensure that the DL105 products operate within their environmental and electrical limits.

## Plan for safety

This catalog should never be used as a replacement for the user manual. The user manual, D1-USER-M, contains important safety information that must be followed. The system installation should comply with all appropriate electrical codes and standards.

## Unit dimensions and mounting orientation

Use the following diagrams to make sure the DL105 system can be installed in your application. DL105 units must be mounted horizontally to ensure proper airflow for cooling purposes. It is important to check these dimensions against the conditions required for your application. For example, we recommend that you leave 2" depth for ease of access and cable clearance; however, your distance may be greater or less. Also, check the installation guidelines for the recommended cabinet clearances.

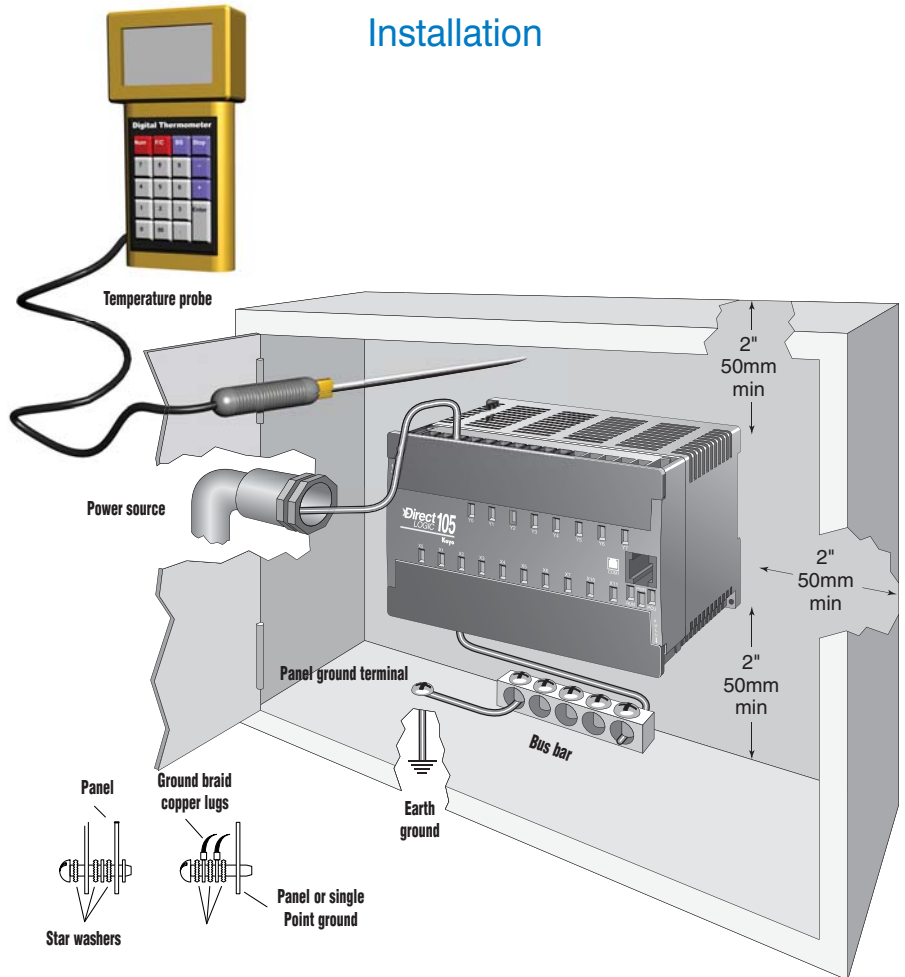

**Note:** There is a minimum of 2" (50mm) clearance required between the panel door or any devices mounted in the panel door and the nearest DL105 component.

## Dimensions and mounting

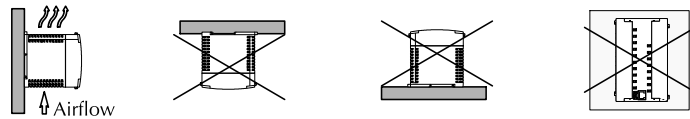

Environmental Specifications	
<b>Storage Temperature</b>	-4°F to 158°F (-20°C to 70°C)
<b>Ambient Operating Temperature</b>	32°F to 131°F (0° to 55°C)
<b>Ambient Humidity</b>	30% to 95% relative humidity (non-condensing)
<b>Vibration Resistance</b>	MIL STD 810C, Method 514.2
<b>Shock Resistance</b>	MIL STD810, Method 516.2
<b>Noise Immunity</b>	NEMA(ICS3-304)
<b>Atmosphere</b>	No corrosive gases

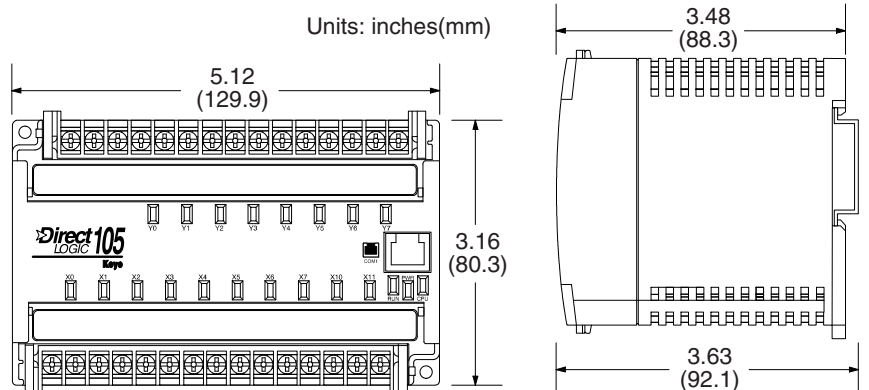

# Power Supply and Type of I/O

## Power supply options

This product family offers units that operate on 110/220 VAC and 12/24 VDC. Choosing the power supply is probably the most important consideration when specifying a DL105 system, since not all I/O combinations are offered with each power supply option. The table to the right provides the I/O choices and power supply specifications for each type unit.

## Choosing the I/O

The DL105 product family offers several different combinations of I/O points. Once you have chosen the power supply option, you need to choose the unit that offers the type of I/O points needed in your application.

## Fixed I/O

All DL105 Micro PLCs have "fixed" I/O that is updated on every scan. This means that all units have 10 inputs and 8 outputs, regardless of the actual type of points on the units (DC in/Relay out, DC in/DC out, etc.) The DL105 micro PLC is non-expandable, so you cannot add I/O points. If you are concerned about future system expansion, check our DL06 (36 base I/O expandable to 100 total I/O), or the DL205 micro-modular product family. The DL205 also offers a wide array of features and flexible I/O arrangements with several different base sizes.

Power Supply Options		
Specification	AC Powered Units	24 VDC Powered Units
<b>Part Numbers</b>	F1-130AA, F1-130AR F1-130AD, F1-130DA F1-130DD, F1-130DR F1-DVNET-AR, F1-DEVNET-DD F1-DVNET-DR	F1-130DD-D F1-130DR-D
<b>Voltage Withstand (dielectric)</b>	one minute @ 1,500 VAC between primary, secondary and field ground	
<b>Insulation Resistance</b>	> 10 MΩ @ 500 VDC	
<b>External Power Requirement</b>	85-132 VAC (110 nominal) 170-264 VAC (220 nominal) 100-264 VDC (125 nominal)	10-30 VDC (12 to 24 VDC) with < 10 percent ripple
<b>Auxiliary 24 VDC Output</b>	500 mA max.	Not available
<b>Maximum Inrush Current</b>	12 A	8 A
<b>Maximum Power</b>	30 VA max.	1 A (approx. 10 W)

## Addresses automatically assigned

The DL105 uses automatic addressing, so for the vast majority of applications, there is no setup required. We use octal addressing for our products, which means there are no 8s or 9s. The first eight input points use addresses X0-X7, and the last two input points use X10 and X11. If you plan on using the high-speed counting features, there is some very minimal setup required in special V-memory locations.

## AC-powered units

Part No.	I/O Mix
F1-130AA	10 Ac in 8 AC out
F1-130AD	10 AC in 8 DC out
F1-130AR	10 AC in 8 relay out
F1-130DA	10 DC in 8 AC out
F1-130DD	10 DC in 8 DC out
F1-130DR	10 DC in 8 relay out

## DC-powered units

Part No.	I/O Mix
F1-130DD-D	10 DC in 8 DC out
F1-130DR-D	10 DC in 8 relay out

