



H2-PBC

Profibus Slave Base Controller User Manual

Manual Number H2-PBC-M



WARNING

Thank you for purchasing automation equipment from **Automationdirect.com™**, doing business as **AutomationDirect**. We want your new **DirectLOGIC™** automation equipment to operate safely. Anyone who installs or uses this equipment should read this publication (and any other relevant publications) before installing or operating the equipment.

To minimize the risk of potential safety problems, you should follow all applicable local and national codes that regulate the installation and operation of your equipment. These codes vary from area to area and usually change with time. It is your responsibility to determine which codes should be followed, and to verify that the equipment, installation, and operation are in compliance with the latest revision of these codes.

At a minimum, you should follow all applicable sections of the National Fire Code, National Electrical Code, and the codes of the National Electrical Manufacturer's Association (NEMA). There may be local regulatory or government offices that can also help determine which codes and standards are necessary for safe installation and operation.

Equipment damage or serious injury to personnel can result from the failure to follow all applicable codes and standards. We do not guarantee the products described in this publication are suitable for your particular application, nor do we assume any responsibility for your product design, installation, or operation.

*Our products are not fault-tolerant and are not designed, manufactured or intended for use or resale as on-line control equipment in hazardous environments requiring fail-safe performance, such as in the operation of nuclear facilities, aircraft navigation or communication systems, air traffic control, direct life support machines, or weapons systems, in which the failure of the product could lead directly to death, personal injury, or severe physical or environmental damage ("High Risk Activities"). **AutomationDirect** specifically disclaims any expressed or implied warranty of fitness for High Risk Activities.*

For additional warranty and safety information, see the Terms and Conditions section of our Desk Reference. If you have any questions concerning the installation or operation of this equipment, or if you need additional information, please call us at 770-844-4200.

This publication is based on information that was available at the time it was printed. At **AutomationDirect** we constantly strive to improve our products and services, so we reserve the right to make changes to the products and/or publications at any time without notice and without any obligation. This publication may also discuss features that may not be available in certain revisions of the product.



Trademarks

This publication may contain references to products produced and/or offered by other companies. The product and company names may be trademarked and are the sole property of their respective owners. **AutomationDirect** disclaims any proprietary interest in the marks and names of others.

**Copyright 2004, Automationdirect.com™ Incorporated
All Rights Reserved**

No part of this manual shall be copied, reproduced, or transmitted in any way without the prior, written consent of **Automationdirect.com™** Incorporated. **AutomationDirect** retains the exclusive rights to all information included in this document.



AVERTISSEMENT



Nous vous remercions d'avoir acheté l'équipement d'automatisation de **Automationdirect.com™**, en faisant des affaires comme **AutomationDirect**. Nous tenons à ce que votre nouvel équipement d'automatisation **DirectLOGIC™** fonctionne en toute sécurité. Toute personne qui installe ou utilise cet équipement doit lire la présente publication (et toutes les autres publications pertinentes) avant de l'installer ou de l'utiliser.

Afin de réduire au minimum le risque d'éventuels problèmes de sécurité, vous devez respecter tous les codes locaux et nationaux applicables régissant l'installation et le fonctionnement de votre équipement. Ces codes diffèrent d'une région à l'autre et, habituellement, évoluent au fil du temps. Il vous incombe de déterminer les codes à respecter et de vous assurer que l'équipement, l'installation et le fonctionnement sont conformes aux exigences de la version la plus récente de ces codes.

Vous devez, à tout le moins, respecter toutes les sections applicables du Code national de prévention des incendies, du Code national de l'électricité et des codes de la National Electrical Manufacturer's Association (NEMA). Des organismes de réglementation ou des services gouvernementaux locaux peuvent également vous aider à déterminer les codes ainsi que les normes à respecter pour assurer une installation et un fonctionnement sûrs.

L'omission de respecter la totalité des codes et des normes applicables peut entraîner des dommages à l'équipement ou causer de graves blessures au personnel. Nous ne garantissons pas que les produits décrits dans cette publication conviennent à votre application particulière et nous n'assumons aucune responsabilité à l'égard de la conception, de l'installation ou du fonctionnement de votre produit.

Nos produits ne sont pas insensibles aux défaillances et ne sont ni conçus ni fabriqués pour l'utilisation ou la revente en tant qu'équipement de commande en ligne dans des environnements dangereux nécessitant une sécurité absolue, par exemple, l'exploitation d'installations nucléaires, les systèmes de navigation aérienne ou de communication, le contrôle de la circulation aérienne, les équipements de survie ou les systèmes d'armes, pour lesquels la défaillance du produit peut provoquer la mort, des blessures corporelles ou de graves dommages matériels ou environnementaux ("activités à risque élevé"). La société **AutomationDirect** nie toute garantie expresse ou implicite d'aptitude à l'emploi en ce qui a trait aux activités à risque élevé.

Pour des renseignements additionnels touchant la garantie et la sécurité, veuillez consulter la section Modalités et conditions de notre documentation. Si vous avez des questions au sujet de l'installation ou du fonctionnement de cet équipement, ou encore si vous avez besoin de renseignements supplémentaires, n'hésitez pas à nous téléphoner au 770-844-4200.

Cette publication s'appuie sur l'information qui était disponible au moment de l'impression. À la société **AutomationDirect**, nous nous efforçons constamment d'améliorer nos produits et services. C'est pourquoi nous nous réservons le droit d'apporter des modifications aux produits ou aux publications en tout temps, sans préavis ni quelque obligation que ce soit. La présente publication peut aussi porter sur des caractéristiques susceptibles de ne pas être offertes dans certaines versions révisées du produit.

Marques de commerce

La présente publication peut contenir des références à des produits fabriqués ou offerts par d'autres entreprises. Les désignations des produits et des entreprises peuvent être des marques de commerce et appartiennent exclusivement à leurs propriétaires respectifs. **AutomationDirect™** nie tout intérêt dans les autres marques et désignations.

Copyright 2004, **Automationdirect.com™** Incorporated

Tous droits réservés

Nulle partie de ce manuel ne doit être copiée, reproduite ou transmise de quelque façon que ce soit sans le consentement préalable écrit de la société **Automationdirect.com™** Incorporated. **AutomationDirect** conserve les droits exclusifs à l'égard de tous les renseignements contenus dans le présent document.

Manual Revisions

If you contact us in reference to this manual, be sure to include the revision number.

Title: H2–PBC Profibus Slave Base Controller Manual

Manual Number: H2–PBC–M

Edition	Date	Description of Changes
Original	05/02	Original issue
1st Edition, Rev A	04/04	Added Extended Diagnostics Appendix Updated GSD File Appendix

Table of Contents

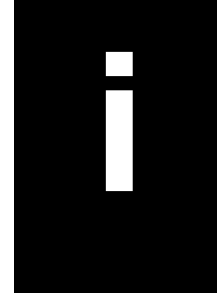

Chapter 1: Introduction

Manual Overview	1-2
Overview of this Manual	1-2
Supplemental Manuals	1-2
Who Should Read this Manual	1-2
Technical Support	1-2
Symbols Used	1-3
Key Topics for Each Chapter	1-3
Introduction to Profibus	1-4
PROFIBUS Concepts	1-4
PROFIBUS International	1-4
PROFIBUS Trade Organization	1-4
DP Communication Profile	1-5
Mini Glossary	1-6

Chapter 2: Installation and Setup

Installing the H2-PBC	2-2
Setting the Node Address	2-2
Setting the Node Address	2-2
Inserting the H2-PBC into the Base	2-3
The Profibus Network	2-4
Wiring the Controller to a PROFIBUS Network	2-4
Status Indicators	2-8
Configuring the Controller	2-8
GSD File	2-8
H2-PBC Configuration	2-9
H2-PBC Memory Map	2-9
Calculating the Power Budget for the DL205 with H2-PBC	2-10
Managing your Power Resource	2-10
PBC Power Specifications	2-10
Module Power Requirements	2-10
Power Consumption Chart (DL205 Modules)	2-11
Power Budget Calculation Example	2-12
Power Budget Calculation Worksheet	2-13

Appendix A: Specifications

H2–PBC Profibus Base Controller	A–2
General Specifications	A–2
Cable Specifications	A–3

Appendix B: H2–PBC Profibus Base Controller GSD File

H2–PBC Profibus DP Base Controller GSD File	B–2
---	-----

Appendix C: DL205 I/O Modules

DL205 Discrete I/O Modules	C–2
DL205 Analog I/O Modules	C–2
DL205 Specialty Modules	C–4

Appendix D: Think & Do Profibus Network Setup with the H2–PBC

Think & Do Profibus Network Setup with H2–PBC	D–2
Getting the T & D Network Started	D–2
T & D Studio setup for PC control	D–2

Appendix E: Siemens Profibus Network Set up with H2–PBC

Setup a H2–PBC on Siemens Profibus Network	E–2
Simantic Manager	E–2

Appendix F: H2–PBC Profibus Extended Diagnostics Error Format

Profibus Extended Diagnostics Error Format	F–2
--	-----

Introduction

In This Chapter. . . .

- Manual Overview
 - Introduction to PROFIBUS
-

Manual Overview

Overview of this Manual

This manual describes the installation and operation of the H2-PBC Profibus Slave Base Controller. You will find the necessary information for installing and configuring the module for use on a Profibus network.

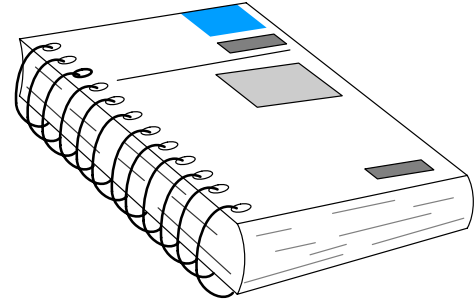

Supplemental Manuals

The following manuals are essential to the proper use of your H2 Profibus Slave Base Controller.

- *DL205 Installation and I/O Manual* part number **D2-INST-M**
- The PLC/PC software manual
- The PROFIBUS software (if separate) manual
- The PROFIBUS networks manual

Who Should Read this Manual

If you have a working knowledge of the PROFIBUS network, the PROFIBUS software and PLC or PC which you are using, this manual will help you configure and install your H2-PBC Profibus Slave Base Controller.

Technical Support

We strive to make our manuals the best in the industry and rely on your feedback in reaching our goal. If you cannot find the solution to your particular application, or, if for any reason you need additional technical assistance, please call us at

770-844-4200.

Our technical support team is glad to work with you in answering your questions. They are available **weekdays from 9:00 a.m. to 6:00 p.m. Eastern Time**. We also encourage you to visit our website where you can find technical and nontechnical information about our products and our company.

www.automationdirect.com

Symbols Used



The “light bulb” icon in the left-hand margin indicates a **tip** or **shortcut**.



The “note pad” icon in the left-hand margin indicates a **special note**.

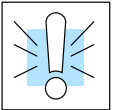

The “exclamation mark” icon in the left-hand margin indicates a **warning** or **caution**. These are very important because the information may help you prevent serious personal injury or equipment damage.

Key Topics for Each Chapter

The beginning of each chapter will list the key topics that can be found in that chapter.

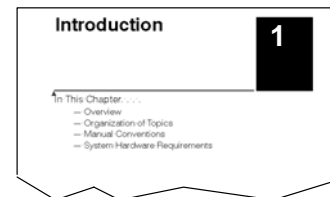

Introduction to Profibus

Profibus (Process Field Bus) is a vendor-independent, open field bus standard that is supported by leading manufacturers of automation products. A host of certified Profibus products are available, offering an array of products including sensors, motor drives and starters, PLCs, remote I/O systems, etc.

Here are some Profibus concepts that you may find helpful.

PROFIBUS Concepts

- Profibus offers three types of profiles.
 - Process Automation (PA)
 - Fieldbus Message Specification (FMS) communication profile
 - Decentralized Periphery (DP)
- Profibus – DP is the most frequently used communication profile.
 - The H2-PBC is a DP slave
 - Master and slave devices, max. 126 stations on one bus
 - Connection oriented communication
 - Transmission rate up to 12 Mbps
 - Peer-to-peer (user data communication) or multicast (control commands)
 - Cyclic master-slave user data communication
 - Control commands allow synchronization of I/O
- Methods for diagnostic and error detection are built into the system

PROFIBUS International

PROFIBUS International (PI) maintains the PROFIBUS standard and provides certification to EN 50170 and IEC 61158 standards for devices. The main purpose of certification is to provide users with the assurance that devices from different manufacturers will work in the same network. Certification is issued by the PROFIBUS Certification Centre in Karlsruhe, Germany.

PROFIBUS Nutzerorganisation e.V.

Haid-und-Neu-Straße 7

D-76131 Karlsruhe

Phone ++49 721 96 58 590, Fax ++49 721 96 58 589

PROFIBUS_International@compuserve.com

PROFIBUS Trade Organization

The PROFIBUS Trade Organization (PTO) is a member of PROFIBUS International. For more detailed information about Profibus, visit the PTO website where technical descriptions and Profibus specifications are available.

PROFIBUS Trade Organization

16101 N. 82nd Street, Suite 3B

Scottsdale, AZ 85260

Phone 480-483-2456, Fax 480-483-7202

Their website is: www.profibus.com

DP Communication Profile

The DP Communication Profile is designed for efficient data exchange at the field level. The central automation devices, such as PLC/PC or process control systems, communicate through a fast serial connection with distributed field devices which can be I/O, drives and valves, as well as measuring transducers. Data exchange with the distributed devices is mainly cyclic.

The master controller cyclically reads the input information from the slaves and cyclically writes the output information to the slaves. The bus cycle time should be shorter than the program cycle time of the central automation system, which for many applications is approximately 10 msec. In addition to cyclic user data transmission, DP provides powerful functions for diagnostics and commissioning. Data communication is monitored by monitoring functions on both the master and slave side.

DP requires only about 1 msec at 12 Mbit/sec for the transmission of 512 bits of input data and 512 bits of output data distributed over 32 stations. The chart below shows the typical time, depending on number of stations and transmission speed. Transmitting the input and output data in a single message cycle with DP, results in a significant increase in speed compared to FMS.

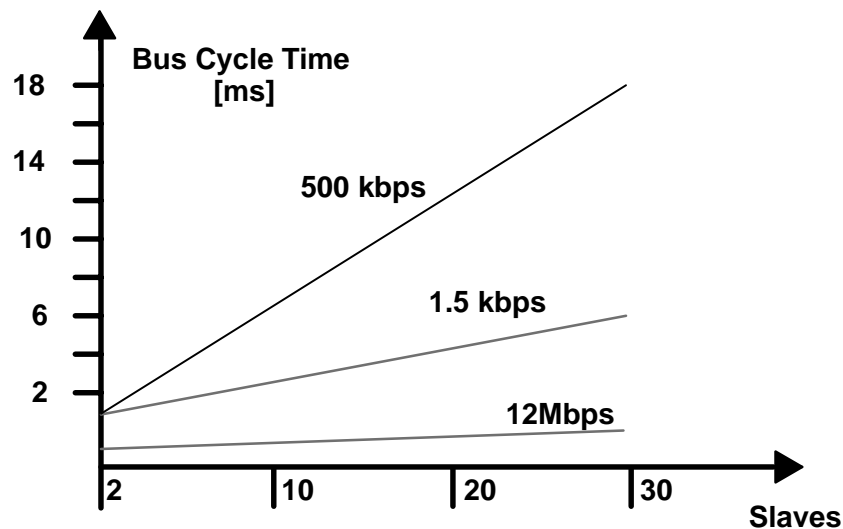

Bus cycle time of a DP mono-master system.

For a more complete description and specification of the Profibus DP communication profile, visit the Profibus Trade Organization web site, www.profibus.com.

Mini Glossary

Below is a small glossary of terms used in this manual.

Mono-Master	Only one Profibus master active on the bus during operation of the bus system of which the H2-PBC is a slave. This can be either a PLC module or a card in your PC.
Multi-Master	Several Profibus masters are connected to one bus. These masters represent either independent subsystems or additional configuration and diagnostic devices.
Slave	a peripheral device (I/O devices, drives, HMI, valves, measuring transducers) which collects input information and sends output information to the peripherals. The H2-PBC is a slave which is also referred to as a controller in a Profibus I/O sub-system.
Segment	One bus structure with a maximum of 32 stations (master or slaves) or nodes. A maximum of 9 segments is possible with the use of repeaters.
Station	A node. Can be a master or a slave.
Repeater	An RS485 device that amplifies data signals on bus lines and is the link between individual bus segments. Used to increase the number of nodes or to extend the cable length between two nodes.
Node Address	The unique device address on a Profibus network. There are a maximum of 126 (0-126). The master is usually node 0.
Token	The bus access right which is assigned to each master within a precisely defined timeframe.

Installation and Setup

In This Chapter. . . .

- Installing the H2–PBC
 - The Profibus Network
 - Configuring the Controller
-

Installing the H2-PBC

Setting the Node Address

Setting the Node Address

Profibus DP is usually a mono master system. Since Profibus is based on a token principle, more than one active station (masters) is allowed. The overall controlling master of the network should be node address "1". The master should be placed at the beginning of the network. Network address "0" should be reserved for monitoring and diagnostic devices.

It is recommended that slave devices begin with address "3". The slave devices need to be addressed in consecutive order by bus location moving away from the master.

Locate the DIP switch on the module and set the Node Address to an available Node Address, from 3 – 125 for the H2-PBC. Node Address 0 is normally reserved for the Profibus network master. Note that each DIP switch position is numbered on the printed circuit board, beginning from the right, 0 (zero) through 7. Each DIP switch position represent the power of 2. Refer to the figure below.

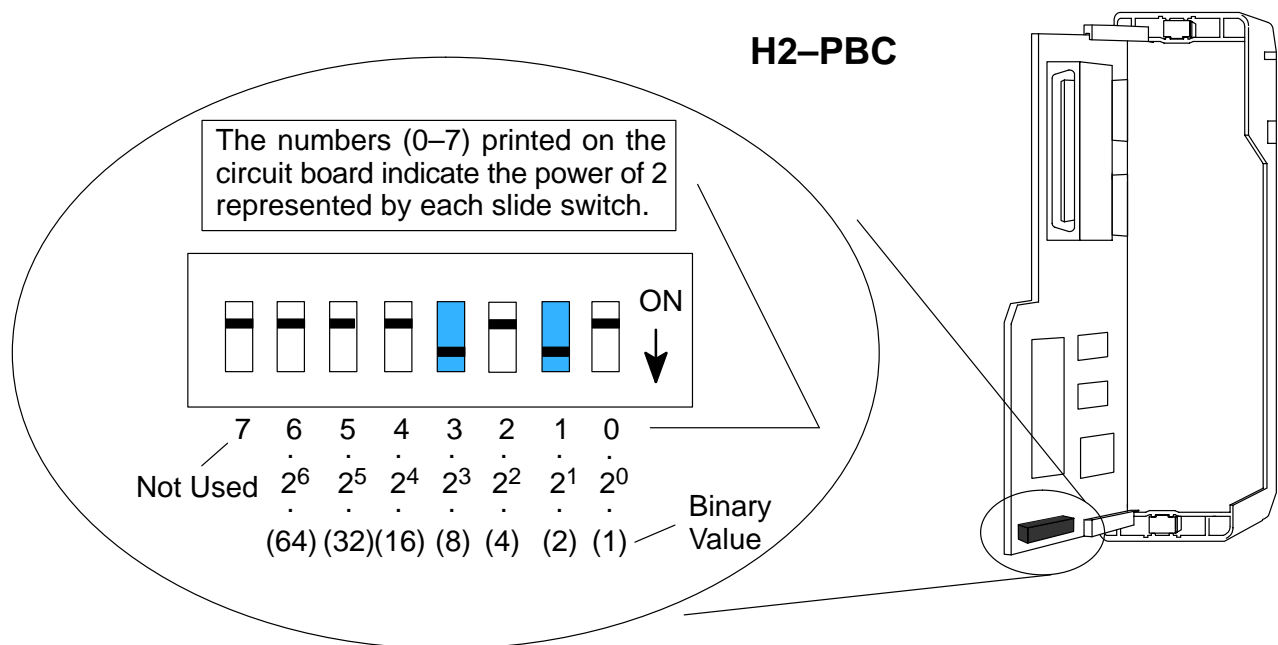

The Node Address equals the *sum* of the binary values of the slide switches set in the ON position. For example, if you set slide switches 1 and 3 to the ON position, the Node Address will be 10. This is found by adding 8+2=10. The maximum value you can set on the DIP switch is 32+16+8+4+2+1=63. This is achieved by setting switches 0 through 5 to the ON position.

Inserting the H2-PBC into the Base

The H2-PBC plugs into the CPU slot of any DL205 base.

- Locate the grooves on the inside top and bottom of the DL205 base.
- Align the module with the grooves and slide the module into the slot until the face of the module is flush with the power supply.
- Push in the retaining clips to secure the module.

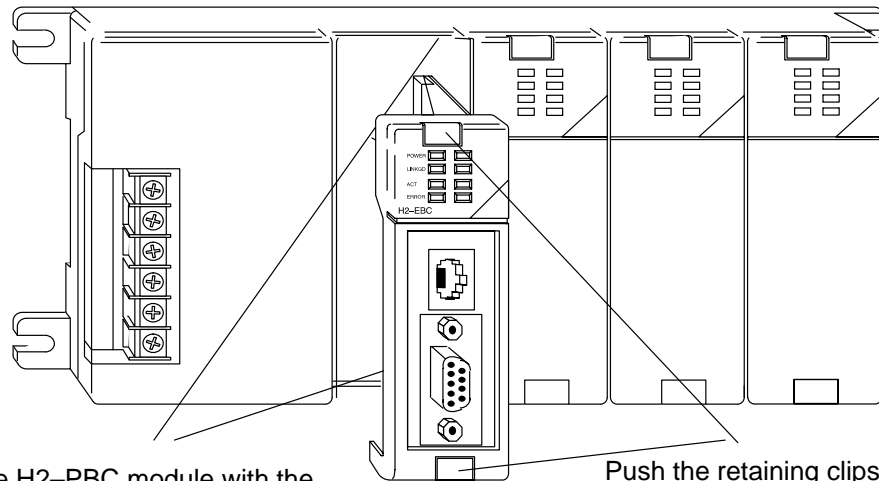

Align the H2-PBC module with the grooves in the base and slide it in.

Push the retaining clips in to secure the module in the DL205 base.

The Profibus Network

RS-485 serial communication is most frequently used by Profibus. Twisted pair shielded copper cable with one conductor pair is the most common cable used for the Profibus network. Installation of this cable does not require expert knowledge. The bus structure permits addition and removal of stations or step-by-step commissioning of the system without interfering with the other stations. Later expansions will not effect the stations which are already in operation. It is important to follow the RS-485 installation guidelines, for 90% of the problems which occur with Profibus networks can be attributed to incorrect wiring and installation.

All devices are connected in a bus structure (line) in a Profibus network. It can be built in several segments with a segment consisting of the maximum number of stations (32) and/or the maximum length of the network. A repeater must be added if there is a need to have more than 32 stations (126 maximum). The bus is terminated by an active bus terminator at the beginning and end of each segment. See the diagram of the termination network below. Both bus terminators should be powered at all times to insure error-free operation. The bus terminator can usually be switched at the device or in the bus terminator connections.

Wiring the Controller to a PROFIBUS Network

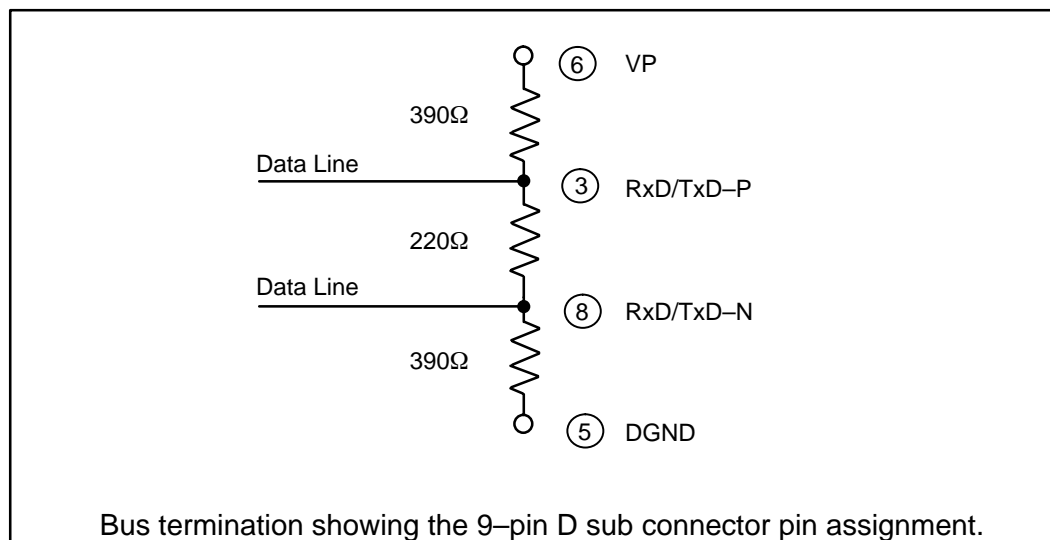

Communication speeds between 9.6 kbps and 12 Mbps are available. One unique baud rate is selected for all devices on the bus when the system is commissioned. The baud rate selected will depend upon the cable length.

The following table shows the maximum network cable lengths for the available baud rates that can be obtained with copper wire.

Baud Rate (bits per second)	Max. Segment Length	Max. Expansion
9.6k	1,000m / 3,278 feet	10,000m / 32,786 feet
19.2k	1,000m / 3,278 feet	10,000m / 32,786 feet
93.75k	1,000m / 3,278 feet	10,000m / 32,786 feet
187.5k	1,000m / 3,278 feet	10,000m / 32,786 feet
500.0k	400m / 1,311 feet	4,000m / 13,114 feet
1,500.0k	200m / 655 feet	2,000m / 6,557 feet
3,000.0k	100m / 327 feet	1,000m / 3,270 feet
6,000.0k	100m / 327 feet	1,000m / 3,270 feet
12,000.0k	100m / 327 feet	1,000m / 3,270 feet

To use baud rates greater than 1.5 Mbps, special connectors are required. The connectors have built in inductors in order to run with higher baud rates (refer to the diagram on page 2-9). Branch lines are not permitted when using baud rates greater than 1.5 Mbps. The minimum recommended cable length between two stations is 1m/3 feet.

The standard EN 50170 specifies the cable for use with Profibus. The following table specifications must be met for Profibus cables.

Cable Specification – Profibus DP	
Impedance	135 to 165 Ω / 3 to 20 MHz
Capacitance	< 30 pf / m
Resistance	< 110 Ω / km
Wire gauge	> 0.64 mm
Conductor area	> 0.34 mm ²

There are several types of Profibus cable available. The most common cable used has solid conductors for the Profibus line. Some recommended cables are: two with solid conductors, Belden Profibus 3079A and Siemens 6XV1 830 0AH10, one with flexible conductors, Bosch Comnet DP #913 548.

The Profibus network is generally connected with a shielded, twisted pair, cable. The shield must to be connected to the protective housing of the connector which is then brought to ground through the connection on the device. Care must be taken when connecting the wires to the connectors that the shield and wires are properly installed.

In many automation control systems, the I/O bus cables are the most important connections between individual systems in the system. Damage to the cable or improper cable installation can lead to problems and often to a breakdown of the entire control system.

To avoid damage to the Profibus cables, install them where they will be clearly visible and separate from all other cables. This will improve EMC characteristics. Install the cables in their own cable trays or conduit separate from all A/C power wiring.

The standard Profibus cable is intended for permanent installation in buildings or in an environment which is protected from the climate. The cable should only be used in applications where there is a minimum of cable flexing and where it will not be exposed to a wet environment.

A 9-pin D-sub connector is required for connecting to Profibus networks using RS-485 for communication. The connector pin assignment and the wiring is shown in the following diagram.

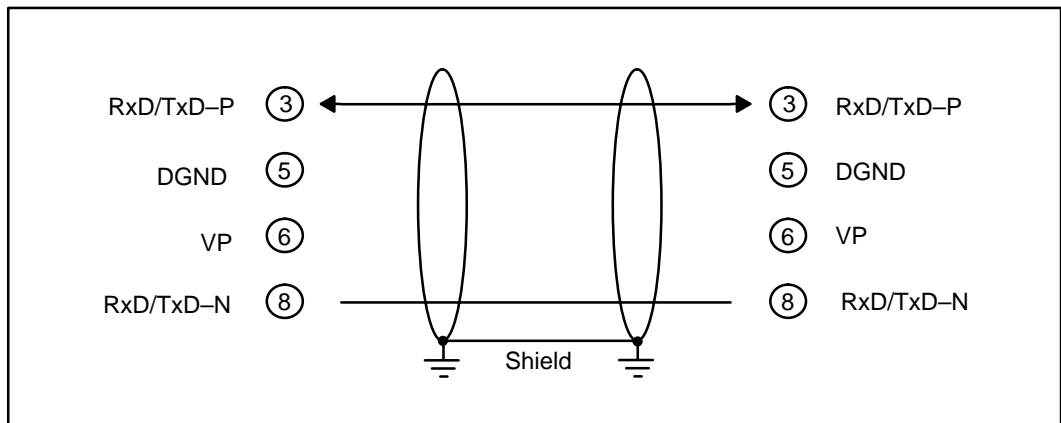

The two wires are usually color coded. Typically red and green are used. Red is used for the **B** Transmit/Receive line and Green for the **A** transmit/receive line. It is important to keep A and B line consistent throughout the network to avoid improper operation. ***This is the most common connection mistake in the field.***

It is recommended that a IP20 protective connector, such as, the Vertical Termination shown in the diagram on the next page, be used for making all terminations for the Profibus network. This is the best way for a quick and easy solution to terminating each end of your Profibus network. AutomationDirect offers two certified connectors for the Profibus Base Controller, one for a standard termination and one for a node termination.

Reverse vertical termination
AutomationDirect Part No. 104322.

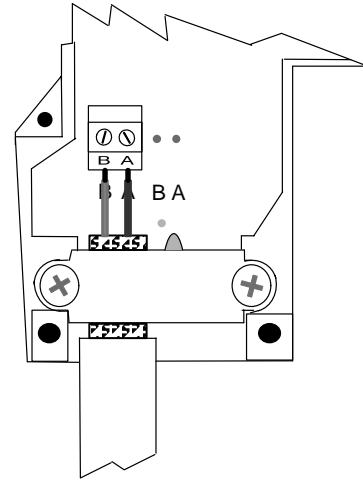

Termination showing the cable connection to points A (Red) and B (Green).

Note: The insulation has been removed exposing the shield. It is connected to ground by the metal clamp holding the cable in place.

Proper preparation of the cable is important for good Profibus network installation. When removing the cable insulation cover, make sure that the braided cable shield is not damaged. Strip the ends of the cable conductors as shown below.

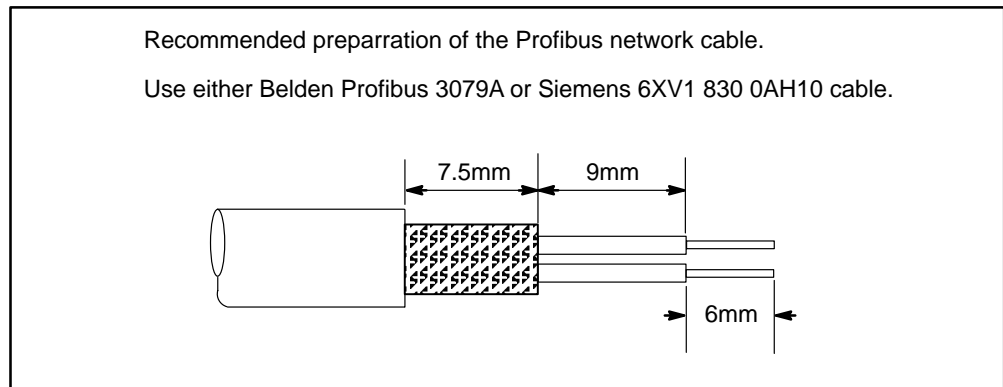

After preparing the cable, insert the green and the red conductors in the appropriate screw terminals of the bus connector.

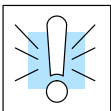

WARNING: The cable shield is not always connected to protective ground within all Profibus devices; therefore, make sure the cable shield is connected to ground before it enters the enclosure.

One important point when setting up a Profibus network is where and how to place the termination. Each Profibus peer-to-peer network, or last segment, needs to be terminated at the beginning and end of a segment (must be at the last device). The termination is usually built into the connector. Power must be supplied to the terminating resistors at the device. This means the last device needs to be powered at all times. If you have to replace the last device, the whole network could become unstable. It is preferred that the master device be installed at the beginning of the network and as a termination point.

Each segment is allowed to have a maximum of 32 stations, and a maximum of 9 segments is possible.

For installation applications where there is electromagnetic interference or to cover longer distances, fiber optic cable can be used for the Profibus field bus networks. Refer to Profibus guideline 2.022 for the specification of the Profibus fiber optic transmission method. For an overview of the fiber optic components available for Profibus, refer to a current Profibus Product Guide which can be found at the Profibus website, www.profibus.com.

Status Indicators

The H2-PBC Profibus Slave Base Controller has four Status Indicators: (Module) Status, (Link) Active, (Holding) Token and Error.

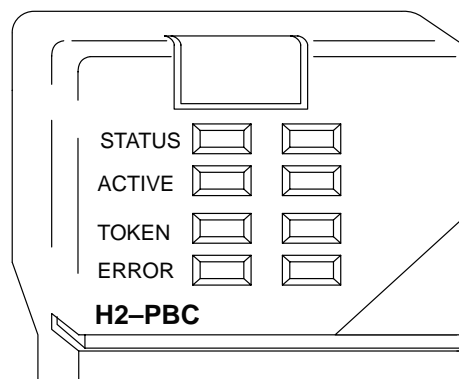

Indicator	Action	Status
STATUS	ON	Powerup check passed
	OFF	Powerup check failed
ACTIVE	ON	Connected to network
	OFF	Not connected to network or incorrect configuration
TOKEN	ON	Correct configuration and running
	OFF	Incorrect configuration and running
ERROR	ON	Watchdog timer timeout

Configuring the Controller

Use the Profibus configuration tool (this should come with the master unit) to configure the master and the H2-PBC for your network. **Refer to the software Help file and/or the manual for assistance with the configuration.**

GSD File

The actual configuration of the H2-PBC takes place whenever the Profibus master is configured. The characteristic communication features of the H2-PBC are defined in the form of an electronic device data sheet, GSD file. The defined file format permits the configuration system to simply read in the GSD files of the H2-PBC and automatically use this information when configuring the bus system. The GSD file is installed in the Profibus master during the configuration of the master.

H2-PBC Configuration

The configuration tool made available with the master controller will allow you to achieve a simple Plug and Play configuration for your Profibus network. Based on the GSD files, the network can be set up with devices from different manufacturers.

1. **Set the Controller Node Address:**

Make sure that the H2-PBC Base Controller node address is set to an available node number on the Profibus network (from 3 to 125).

2. **Configure the Profibus master:**

Configure the Profibus master with the Profibus Configuration Tool that was supplied with the master controller to configure the H2-PBC and the DL205 I/O.

3. **Add the GSD file:**

When configuring the Profibus master, add the H2-PBC slave GSD file from the disk which came with this manual or from our web site www.automationdirect.com.

4. **Commission the Node:**

Use the Profibus Configuration Tool used to configure the master to put the system on line.

5. **Scan the I/O:**

Use the monitor utility that comes with the configuration tool to scan the DL205 I/O.

6. **View Indicators on the H2-PBC module:**

Refer to the Status Indicators when connecting to the network.

H2-PBC Memory Map

The Profibus DP slave memory map specification per station will allow up to 244 bytes of input data and 244 bytes of output data to be transmitted. This is well within the range for the DL205 I/O modules. The H2-CTRIO module will be limited to no more than four modules per H2-PBC station due to the power budget restraints.

Calculating the Power Budget for the DL205 with H2-PBC

Managing your Power Resource

When determining which I/O modules you will be using in the H2-PBC system, it is important to remember that there is a limited amount of power available from the power supply. A table has been provided here showing the power available from the various DL205 base power supplies and a table showing the maximum power consumed by the H2-PBC and each of the I/O modules supported by the H2-PBC. Following these two tables is an example of a completed power budgeting worksheet and then a blank worksheet you can use for your own calculations.

If the I/O modules you choose exceed the maximum power available from the smaller DL205 base power supplies, you will need to use a D2-09B 9-slot base. This base supplies more power than the other bases, as you can see in the table below.



WARNING: It is *extremely* important to calculate the power budget. If you exceed the power budget, the system may operate in an unpredictable manner which may result in a risk of personal injury or equipment damage.

PBC Power Specifications

The following table shows the amount of electrical current available at the two voltages supplied from the DL205 base. Use these values when calculating the power budget for you system.

The Auxiliary 24V power source mentioned in the table is available at the base terminal strip. You can connect to external devices or DL205 I/O modules that require 24VDC, but be sure not to exceed the maximum current supplied.

Bases	5V Current Supplied	Auxiliary 24VDC Current Supplied
D2-03B-1	2600 mA	300 mA
D2-04B-1	2600 mA	300 mA
D2-06B-1	2600 mA	300 mA
D2-09B-1	2600 mA	300 mA
D2-03B1-1	2600 mA	None
D2-04B1-1	2600 mA	None
D2-06B1-1	2600 mA	None
D2-09B1-1	2600 mA	None
D2-03BDC-2	1550 mA	200 mA
D2-04BDC-2	1550 mA	200 mA
D2-06B2-1	2600 mA	300 mA
D2-09B2-1	2600 mA	300 mA

Module Power Requirements

The chart on the next page shows the maximum amount of electrical current required to power each of the DL205 PBC or I/O modules. Use these values when calculating the power budget for your system.

Power Consumption Chart (DL205 Modules)

Module	5V Power Required (mA)	External Power Source Required
PBC Module		
H2-PBC	530	None
DC Input Modules		
D2-08ND3	50	None
D2-16ND3-2	100	None
D2-32ND3/-2	25	None
AC Input Modules		
D2-08NA-1	50	None
D2-08NA-2	100	None
D2-16NA	100	None
DC Output Modules		
D2-04TD1	60	20
D2-08TD1/2	100	None
D2-16TD1-2	200	24 VDC @ 80 mA max
D2-16TD2-2	200	0
D2-32TD1/2	350	0
AC Output Modules		
D2-08TA	250	None
D2-12TA	350	None
Relay Output Modules		
D2-04TRS	350	None
D2-08TR	250	None
D2-12TR	450	None
F2-08TR	670	None
F2-08TRS	670	None
Combination Modules		
D2-08CDR	200	0
Analog		
F2-04AD-1(L)	50	18-30 VDC @ 80 mA max; (-L) 10-15VDC @ 90mA
F2-04AD-2(L)	60	18-26.4 VDC @ 80 mA max; (-L) 10-15VDC @ 90mA
F2-08AD-1	50	18-26.4 VDC @ 80 mA max
F2-08AD-2	60	18-26.4 VDC @ 80 mA max
F2-02DA-1(L)	40	18-30VDC @ 60mA; (L) 10-15VDC @ 70mA (add 20mA / loop)
F2-02DA-2(L)	40	18-30 VDC @ 60 mA max; (-L) 10-15VDC @ 70mA
F2-02DAS-1	100	18-32VDC @ 50mA per channel
F2-02DAS-2	60	21.6-26.4 VDC @ 60 mA per channel
F2-08DA-2	60	18-30 VDC @ 80 mA max
F2-04AD2DA	110	18-26.4VDC @ 80mA; add 20mA / loop
F2-04RTD	90	0
F2-04THM	110	18-26.4 VDC @ 60 mA max
Specialty Modules		
D2-CTRINT	50	5 VDC @ 60 mA max (required for outputs only)
H2-CTRO	400	5 VDC Maximum of 6 watts (All I/O in ON state at max. voltage/current).

Power Budget Calculation Example

The following example shows how to calculate the power budget for the H2-PBC system.

Base #	Module Type	5 VDC (mA)	Auxiliary Power Source 24 VDC Output (mA)
<u>1</u>			
Available Base Power	D2-09B	2600	300
PBC	H2-PBC	+ 530	+ 0
Slot 0	D2-16ND3-2	+ 100	+ 0
Slot 1	D2-16NA	+ 100	+ 0
Slot 2	D2-16NA	+ 100	+ 0
Slot 3	F2-04AD-1	+ 50	+ 80
Slot 4	F2-02DA-1	+ 40	+ 100
Slot 5	D2-08TA	+ 250	+ 0
Slot 6	D2-08TD1	+ 100	+ 0
Slot 7	D2-08TR	+ 250	+ 0
Other			
Maximum Power Required		1520	180
Remaining Power Available		2600-1520= 1080	300 - 170 = 120

- Using the table on the previous page, fill in the information for the base power supply, the H2-PBC, I/O modules, and any other devices that will use system power including devices that use the 24 VDC output.
- Add the current columns starting with the row for Slot 0 and working your way down to the "Other" category. Put the total in the row labeled "Maximum power required".
- Subtract the row labeled "Maximum power required" from the row labeled "Available Base Power". Place the difference in the row labeled "Remaining Power Available".
- If "Maximum Power Required" is greater than "Available Base Power" in either of the two columns, the power budget will be exceeded. It will be unsafe to use this configuration, and you will need to restructure your I/O.

Power Budget Calculation Worksheet

This blank chart is provided for you to copy and use in your power budget calculations.

Base # <u>0</u>	Module Type	5 VDC (mA)	Auxiliary Power Source 24 VDC Output (mA)
Available Base Power			
CPU Slot			
Slot 0			
Slot 1			
Slot 2			
Slot 3			
Slot 4			
Slot 5			
Slot 6			
Slot 7			
Other			
Total Power Required			
Remaining Power Available			

1. Using the table on the previous page, fill in the information for the base power supply, the H2-PBC, I/O modules, and any other devices that will use system power including devices that use the 24 VDC output.
2. Add the current columns starting with the row for Slot 0 and working your way down to the “**Other**” category. Put the total in the row labeled “**Maximum power required**”.
3. Subtract the row labeled “**Maximum power required**” from the row labeled “**Available Base Power**”. Place the difference in the row labeled “**Remaining Power Available**”.
4. If “**Maximum Power Required**” is greater than “**Available Base Power**” in either of the two columns, the power budget will be exceeded. It will be unsafe to use this configuration, and you will need to restructure your I/O.

Specifications

In This Appendix. . . .
— Specifications

Specifications

H2-PBC Profibus Base Controller

Module Type	Profibus Network Interface Module
Maximum Expansion	32 stations per segment, 9 repeaters max./segment, 126 stations maximum
Communications	RS-485
Auto-configuring	GSD file in Master
Profibus Profile	DP
Profibus Port	9-pin D-shell
Node Address	3 to 125 (decimal) set by DIP switches (0 used by the Master)
Segment distance	100 meters (327 feet) to 1200 meters (3270 feet)
Baud Rate	Selectable from 9.6 kbps to 12 Mbps
LED Indicators	STATUS (Module): ON = module power-up check passed OFF = module power-up check failed ACTIVE (Link): ON = Network is active OFF = Network is not active TOKEN (Holding): ON = PBC is configured correctly and running OFF = Incorrect I/O configuration ERROR: ON = watchdog timer timeout represents hardware, communications, or network fault; power-on reset or reset within master device software
Communications Port	RJ12, RS232C (used for firmware upgrade only)
Base Power Requirement	530mA @ 5VDC (supplied by base power supply)

General Specifications

Installation Requirements	Installs in CPU slot
Operating Temperature	32° F to 131° F (0° C to 55° C)
Storage Temperature	-4° F to 158° F (-20° C to 70° C)
Relative Humidity	5 to 95% (non-condensing)
Environmental Air	No corrosive gases, pollution level = 2 (UL 840)
Vibration	MIL STD 810C 514.2
Shock	MIL STD 810C 516.2
Noise Immunity	NEMA ICS3-304 Impulse noise 1us, 1000V FCC class A RFI (144MHz, 430MHz, 10W, 10cm)
Manufacturer	Host Automation Products

Cable Specifications

Permitted Ambient Conditions	
Operating Temperature	32° F to 131° F (-40° C to 60° C)
Storage Temperature	-4° F to 158° F (-40° C to 60° C)
Installation Temperature	(-40° C to 60° C)
Bending Radius	
First and final bend	>= 75 mm
Repeated bending	>= 150 mm

H2-PBC Profibus Base Controller GSD File

In this Appendix. . . .
— H2-PBC GSD File

H2-PBC Profibus DP Base Controller GSD File

This appendix shows the contents of the GSD file for the H2-PBC Profibus Base Controller. It is included for reference only. The electronic data diskette is included with this manual. The latest GSD file is always available for download on the www.AutomationDirect.com website. It can always be downloaded from the GSD Library located on the Profibus Trade Organization website www.profibus.com.

```

=====
; GSD File For AutomationDirect.com H2-PBC
; using the SPC3 ASIC
; Version: V0.2
=====
#Profibus_DP
GSD_Revision=2

;General parameters
Vendor_Name   = "AutomationDirect.com"
Model_Name    = "H2-PBC"
Revision      = "V1.0"
Ident_Number  = 0x0608
Protocol_Ident = 0
Station_Type  = 0
FMS_supp     = 0
Hardware_Release= "REV. 2"
Software_Release= "REV 1.1.19"
9.6_supp     = 1
19.2_supp    = 1
45.45_supp   = 1
93.75_supp   = 1
187.5_supp   = 1
500_supp     = 1
1.5M_supp    = 1
3M_supp      = 1
6M_supp      = 1
12M_supp     = 1
MaxTsd_9.6   = 60
MaxTsd_19.2  = 60
MaxTsd_45.45 = 250
MaxTsd_93.75 = 60
MaxTsd_187.5 = 60
MaxTsd_500   = 100
MaxTsd_1.5M  = 150
MaxTsd_3M    = 250

```



```
; DISCRETE OUTPUT MODULES
Module="4 POINT DISCRETE OUTPUT" 0x20
EndModule
Module="8 POINT DISCRETE OUTPUT" 0x20
EndModule
Module="12 POINT DISCRETE OUTPUT" 0x21
EndModule
Module="16 POINT DISCRETE OUTPUT" 0x21
EndModule
Module="32 POINT DISCRETE OUTPUT" 0x23
EndModule

; COMBINATION I/O MODULE
Module="4 IN / 4 OUT DISCRETE COMBO" 0xC0,0x00,0x00
EndModule

; ANALOG INPUT MODULES
Module="4 CHANNEL ANALOG INPUT" 0x53
EndModule
Module="8 CHANNEL ANALOG INPUT" 0x57
EndModule

; ANALOG OUTPUT MODULES
Module="2 CHANNEL ANALOG OUTPUT" 0x61
EndModule
Module="8 CHANNEL ANALOG OUTPUT" 0x67
EndModule

; COMBINATION ANALOG INPUT/ANALOG OUTPUT MODULE
Module="4 IN / 2 OUT ANALOG COMBO" 0xC0,0x41,0x43
EndModule

; DC INPUT MODULES
Module="D2-08ND3 8PT DISCRETE INPUT" 0x10
EndModule
Module="D2-16ND3-2 16PT DISCRETE INPUT" 0x11
EndModule
Module="D2-32ND3 32PT DISCRETE INPUT" 0x13
EndModule
Module="D2-32ND3-2 32PT DISCRETE INPUT" 0x13
EndModule
```



```
; AC INPUT MODULES
Module="D2-08NA-1 8PT DISCRETE INPUT" 0x10
EndModule
Module="D2-08NA-2 8PT DISCRETE INPUT" 0x10
EndModule
Module="D2-16NA 16PT DISCRETE INPUT" 0x11
EndModule
; INPUT SIMULATOR MODULES
Module="F2-08SIM 8PT INPUT SIMULATOR" 0x10
EndModule

; DC OUTPUT MODULES
Module="D2-04TD1 4PT DISCRETE OUTPUT" 0x20
EndModule
Module="D2-08TD1 8PT DISCRETE OUTPUT" 0x20
EndModule
Module="D2-08TD2 8PT DISCRETE OUTPUT" 0x20
EndModule
Module="D2-16TD1-2 16PT DISCRETE OUTPUT" 0x21
EndModule
Module="D2-16TD2-2 16PT DISCRETE OUTPUT" 0x21
EndModule
Module="D2-32TD1 32PT DISCRETE OUTPUT" 0x23
EndModule
Module="D2-32TD2 32PT DISCRETE OUTPUT" 0x23
EndModule

; AC OUTPUT MODULES
Module="D2-08TA 8PT DISCRETE OUTPUT" 0x20
EndModule
Module="D2-12TA 12PT DISCRETE OUTPUT" 0x21
EndModule

; RELAY OUTPUT MODULES
Module="D2-04TRS 4PT RELAY OUTPUT" 0x20
EndModule
Module="D2-08TR 8PT RELAY OUTPUT" 0x20
EndModule
Module="F2-08TR 8PT RELAY OUTPUT" 0x20
EndModule
Module="F2-08TRS 8PT RELAY OUTPUT" 0x20
EndModule
Module="F2-08TA 8PT TRIAC OUTPUT" 0x20
EndModule
Module="D2-12TR 12PT RELAY OUTPUT" 0x21
EndModule

; COMBINATION I/O MODULE
Module="D2-08CDR 4PT INPUT/OUTPUT" 0xC0,0x00,0x00
EndModule
```

```
; ANALOG INPUT MODULES
Module="F2-04AD-1 4CH ANALOG INPUT" 0x53
EndModule
Module="F2-04AD-1L 4CH ANALOG INPUT" 0x53
EndModule
Module="F2-04AD-2 4CH ANALOG INPUT" 0x53
EndModule
Module="F2-04AD-2L 4CH ANALOG INPUT" 0x53
EndModule
Module="F2-08AD-1 8CH ANALOG INPUT" 0x57
EndModule
Module="F2-08AD-2 8CH ANALOG INPUT" 0x57
EndModule
Module="F2-04RTD 4CH RTD INPUT" 0x53
EndModule
Module="F2-04THM 4CH THERMOCOUPLE INPUT" 0x53
EndModule

; ANALOG OUTPUT MODULES
Module="F2-02DA-1 2CH ANALOG OUTPUT" 0x61
EndModule
Module="F2-02DA-1L 2CH ANALOG OUTPUT" 0x61
EndModule
Module="F2-02DA-2 2CH ANALOG OUTPUT" 0x61
EndModule
Module="F2-02DA-2L 2CH ANALOG OUTPUT" 0x61
EndModule
Module="F2-02DAS-1 2CH ANALOG OUTPUT" 0x61
EndModule
Module="F2-02DAS-2 2CH ANALOG OUTPUT" 0x61
EndModule
Module="F2-08DA-2 8CH ANALOG OUTPUT" 0x67
EndModule
Module="F2-08DA-1SS 8CH ANALOG OUTPUT" 0x67
EndModule

; COMBINATION ANALOG INPUT/ANALOG OUTPUT MODULE
Module="F2-04AD2DA ANALOG 4INPUT/2OUTPUT" 0xC0,0x41,0x43
EndModule

; H2-CTRIO Counter MODULE
; 48 Bytes Output and 40 Bytes Input
Module="H2-CTRIO Counter Module" 0xC0,0xAF,0xA7
EndModule
```

DL205 I/O Modules

In This Appendix. . . .

— Supported DL205 I/O Modules

Supported DL205 I/O Modules

DL205 Discrete I/O Modules

Input Modules

D2-08ND3
D2-16ND3-2
D2-32ND3
D2-32ND3-2
D2-08NA-1
D2-08NA-2
D2-16NA
F2-08SIM

Output Modules

D2-04TD1
D2-08TD1
D2-08TD2
D2-16TD1-2
D2-16TD2-2
D2-32TD1
D2-32TD2
D2-08TA
D2-12TA
D2-04TRS
D2-08TR
D2-12TR
F2-08TA
F2-08TR
F2-08TRS

Combination Modules

D2-08CDR

DL205 Analog I/O Modules

Input Modules

F2-04AD-1
F2-04AD-1L
F2-04AD-2
F2-04AD-2L
F2-08AD-1
F2-08AD-2
F2-04RTD
F2-04THM

Output Modules

F2-02DA-1
F2-02DA-1L
F2-02DA-2
F2-02DA-2L
F2-02DAS-1
F2-02DAS-2
F2-08DA-1
F2-08DA-2

Combination Modules

F2-04AD2DA

Specialty Modules

H2-CTRIO

Think & Do Profibus Network Setup with the H2–PBC

In This Appendix. . . .

— Think & Do Profibus Network Setup

Think & Do Profibus Network Setup with H2-PBC

For those who are using the H2-PBC as a slave with Think & Do, the following steps will guide you through the setup for your Think & Do Profibus network.

Getting the T & D Network Started

The first thing that will be needed for the Think & Do Profibus network is a Profibus interface card for your PC. We use the SST™ Interface Card for Profibus, produced by Woodhead Industries, Inc.. More information about the purchase of this card can be obtained from their website, www.mySST.com. The PC used for the setup procedure explained here uses this interface card. Whenever this card has been installed, run the SST Profibus Configuration Tool to configure the Profibus card before beginning the Think & Do setup.

The following setup uses Think & Do Studio; however, if you have Think & Do LIVE installed on your PC, you will use I/O View instead of the Connectivity Center to setup the H2-PBC DP Slave on the network.

T & D Studio setup for PC control

First, Be sure that the Node Address has been set to a proper address (3 to 125 for the H2-PBC). Next, open Think & Do Studio and select **File > New** in the Project Center window. Use the following procedure to setup the H2-PBC with Think & Do Studio. The procedure assumes that the Profibus cable is connected from the SST card to your H2-PBC Profibus Base Controller with Terminator I/O installed.

1. Rename the project (the example name is PROFIBUS).
2. Click on the **ConnectivityCenter** button.

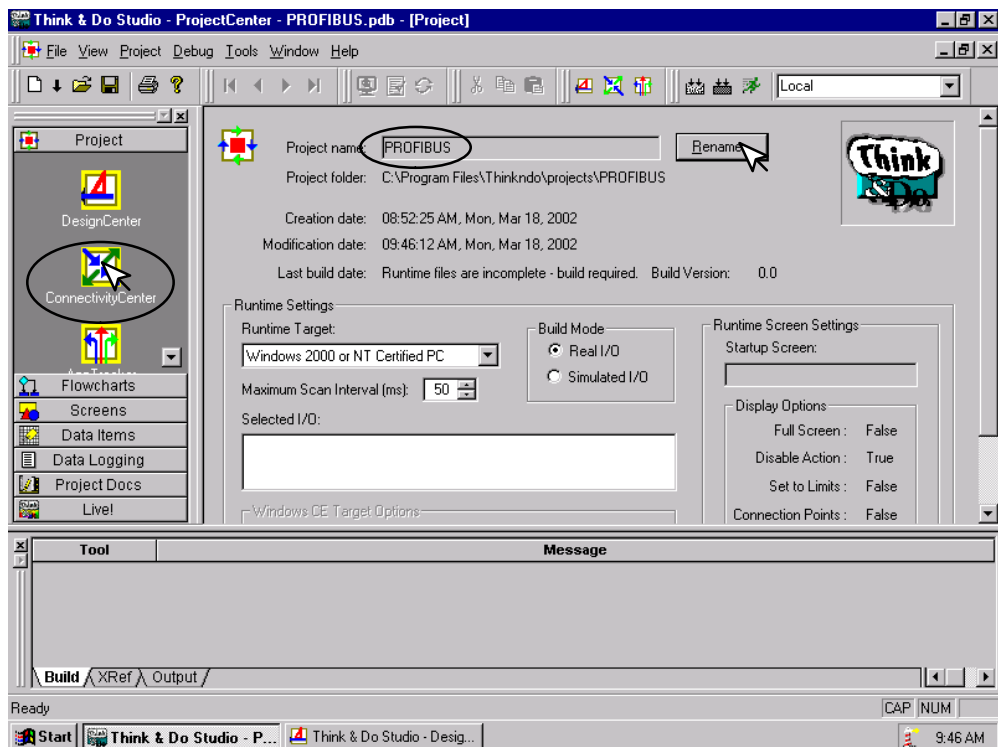

This window will appear with a note to add the I/O driver.

3. Click on **Drivers** > **Add** in the drop down window which appears.

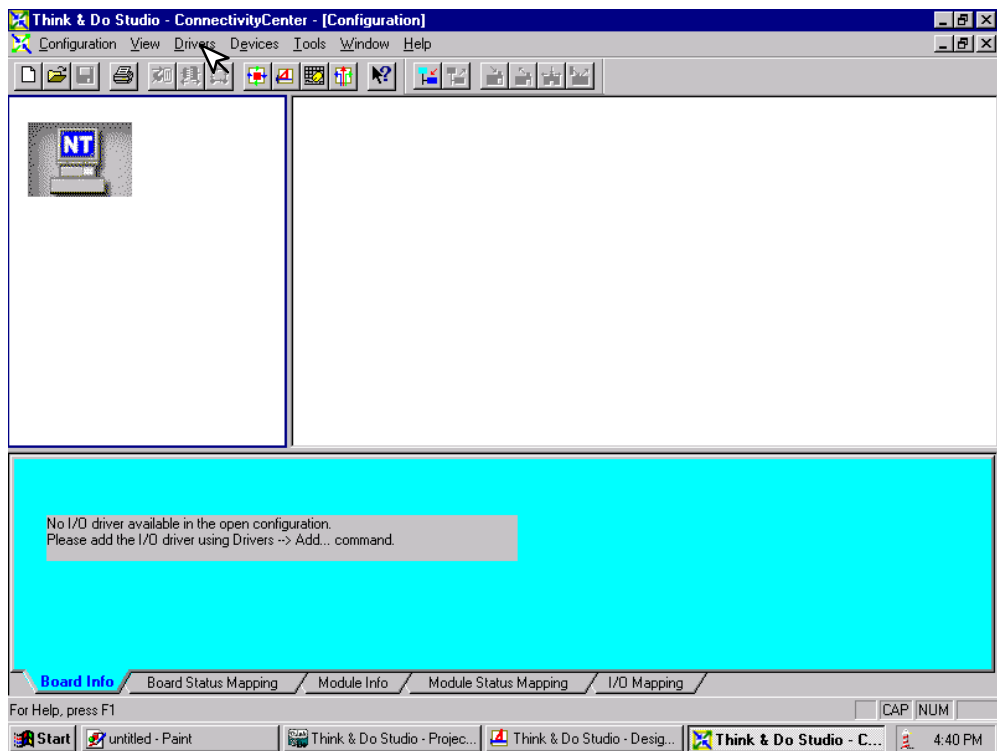

The **Add I/O Driver** window will drop down.

4. Click on the down arrow and select the Profibus driver that is in your PC.

5. Click **OK**.

This installs the SST driver to Think & Do configuration.

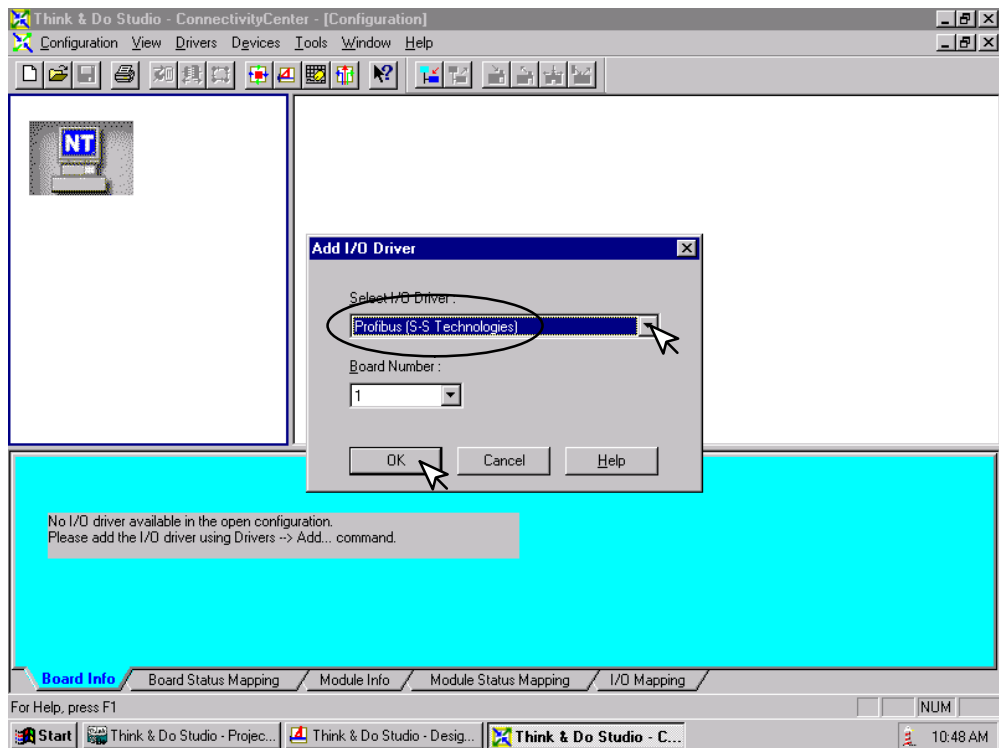

The H2-PBC Slave must be added to the configuration next.

6. Click on **Devices** or the **Add Device** button in this window.

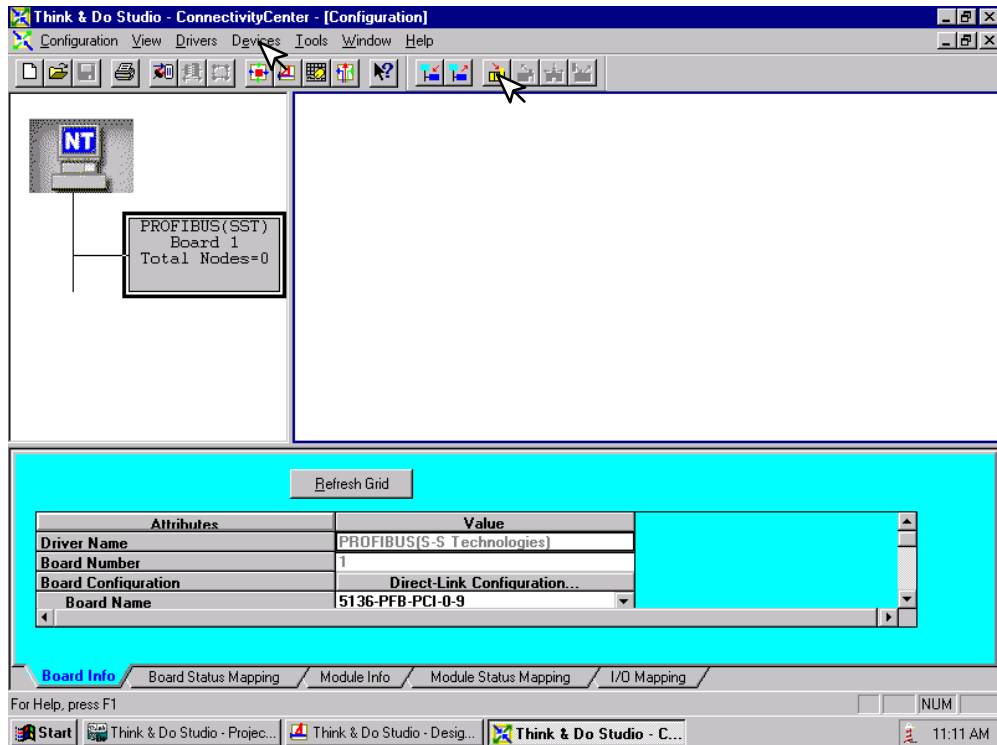

The following window will come into view. You will see a list of companies in the window on the left. Each of these have GSD files that are supported by Think & Do. If AutomationDirect is not in the list, you will need to install the GSD file from the diskette that was supplied with this manual.

7. Click the **Add** button.

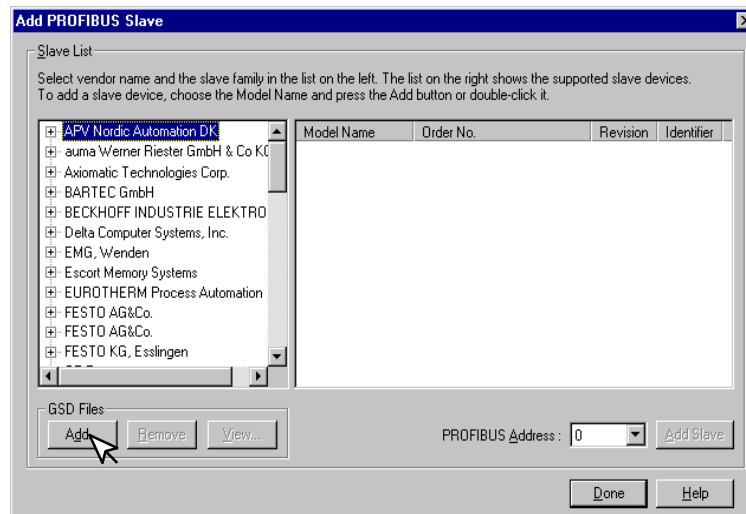

When this window comes into view, insert the diskette and select the A: drive in the **Look in:** window slot.

7. Click on **Autd0608.gsd** file to select the **File name**, then **Add**.

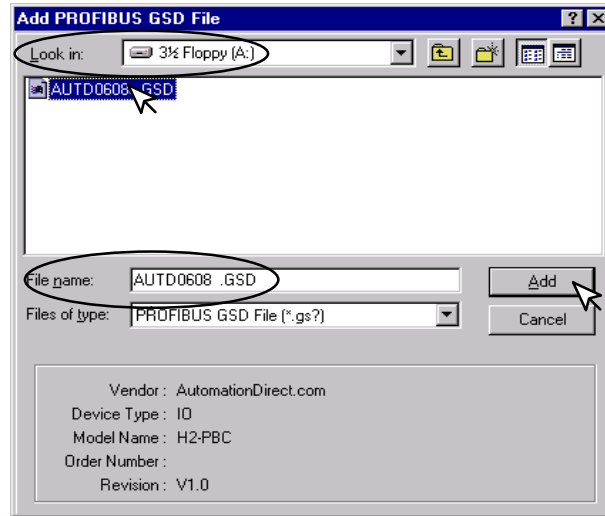

The window appears like the one shown below.

8. Click on **AutomationDirect.com**, then **IO**. This puts the available GSD file names in the window on the right.
9. Select **H2-PBC** and enter the **PROFIBUS Address** set on the DIP switch.
10. Click on **Add Slave**, then **Done**.

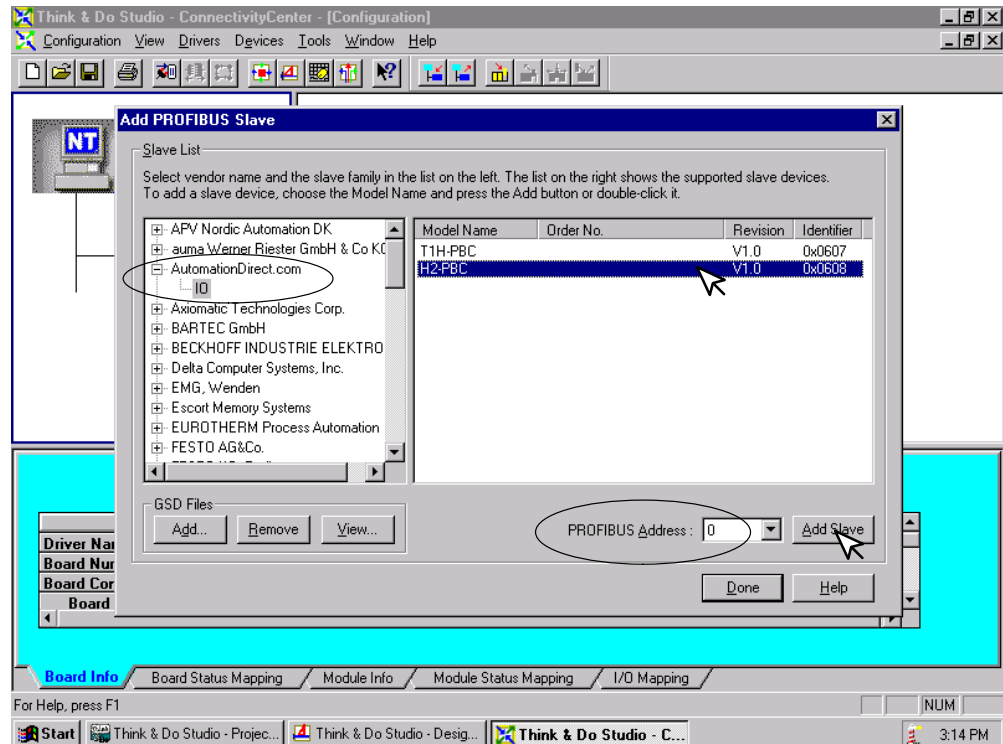



Once the GSD file has been added, simply click the Connect button after installing the Profibus I/O driver the next time that a slave is configured. Think & Do Studio will search the network for all connected slaves and the modules for each slave. You will need to select the name for each module found.

The window now displays the **H2-PBC** as a block with the name and address.

Now that the H2-PBC Slave has been added to the configuration, add the DL205 I/O modules which are installed in the base.

11. Either click on **Devices** or the **Add Device** button.

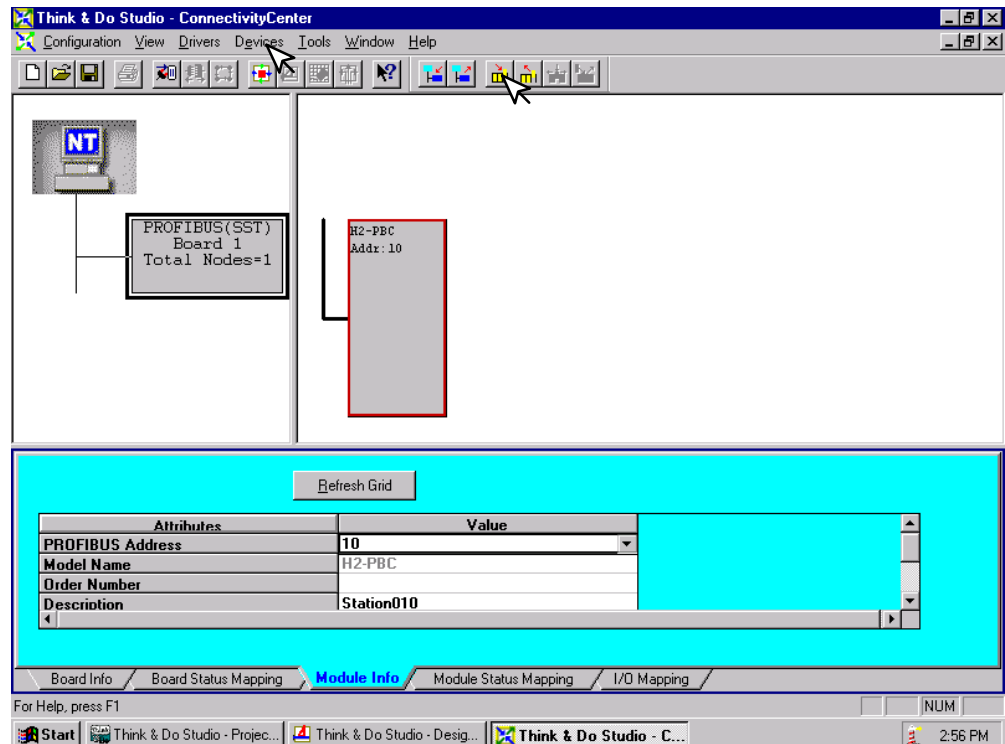

The **Add I/O Module to Modular Slave** window will drop down. Select the module for Slot 1 by clicking on the down arrow next to the **I/O Module**. Either select the generic name or the part number for the DL205 module located in that slot.

12. Click the **OK** button.

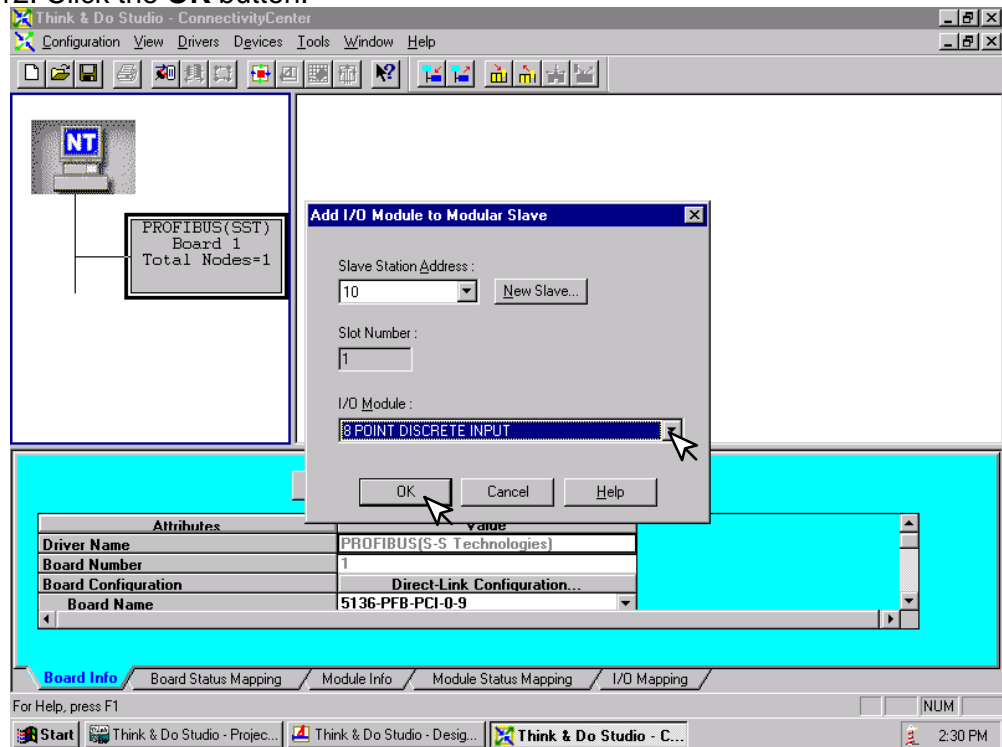

Repeat these steps for each slot until all of the DL205 I/O modules have been added to your H2-PBC Slave configuration.

The configuration window now shows the complete H2-PBC Slave Base Controller connected to the Think & Do network. It can now be connected and put on line.

13. Either click on **Configuration > Connect** or on the **Connect** button.

14. After it is connected either click on **Configuration > Scan** or the **Scan** button.

The system should now be running.

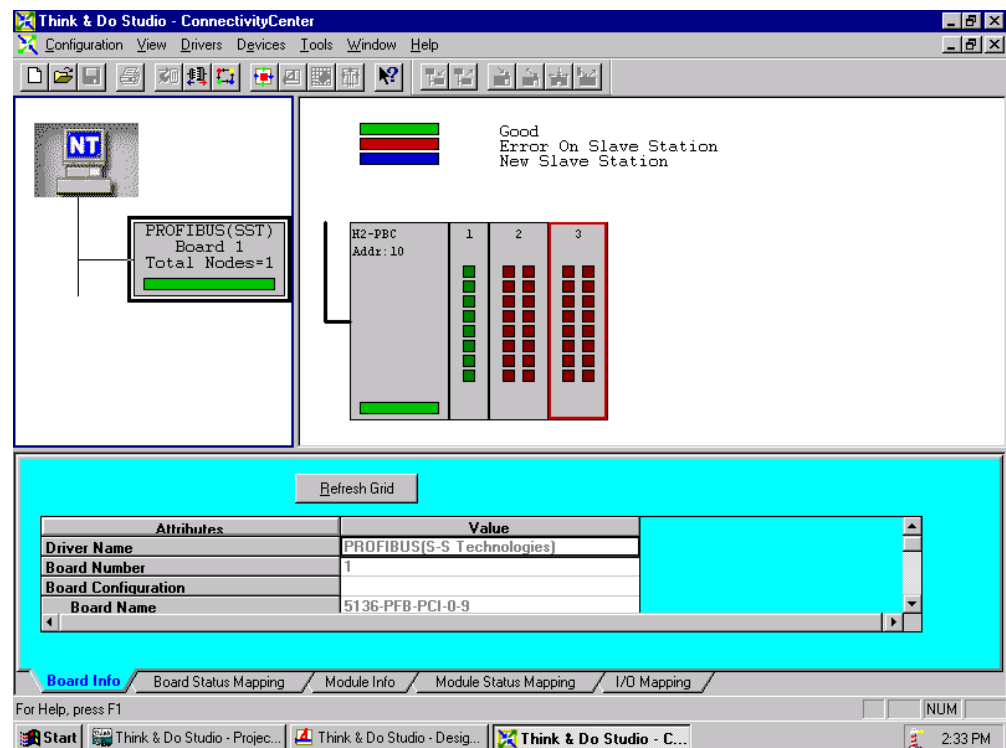

Siemens Profibus Network Set up with H2–PBC

In This Appendix. . . .

— Siemens Profibus Network Setup with a H2–PBC

Setup a H2-PBC on Siemens Profibus Network

For those who are using the H2-PBC slave on a Profibus network with a Siemens PLC, the examples on the following pages will step you through the process of setting up your network. The PLC used as Profibus master in this example is a Simatic 300.

Simatic Manager Begin by opening your SIMATIC Manager to configure the Profibus driver.

1. Use the hardware configuration to select the PLC processor.
2. Open the catalog window by clicking on the **Catalog** button, and select the proper S7 processor.

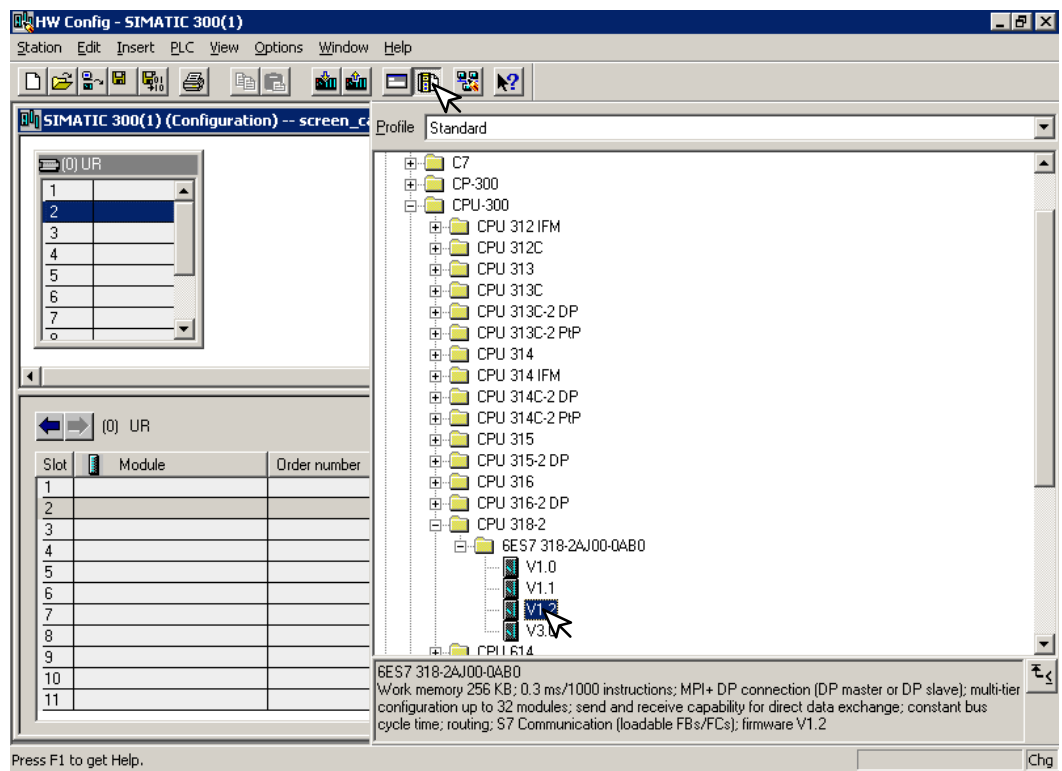

After selecting the processor, the DP interface properties window will pop-up.

3. Select **New**, and **OK**.

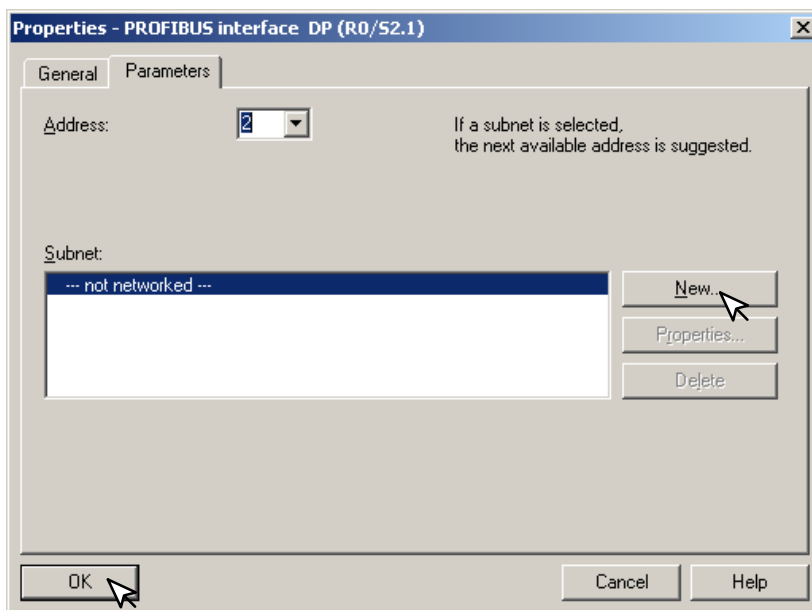

The New subnet window will appear allowing you to name the subnet. The new ID is also in the window.

4. Make the necessary entries, then click **OK**.

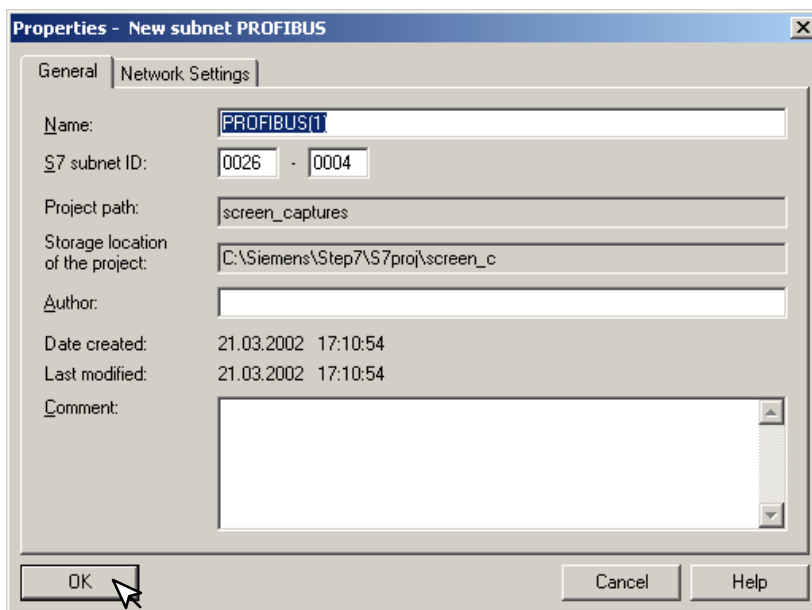

Once the processor has been selected and the DP network is enabled, the configuration window should look like the diagram below.

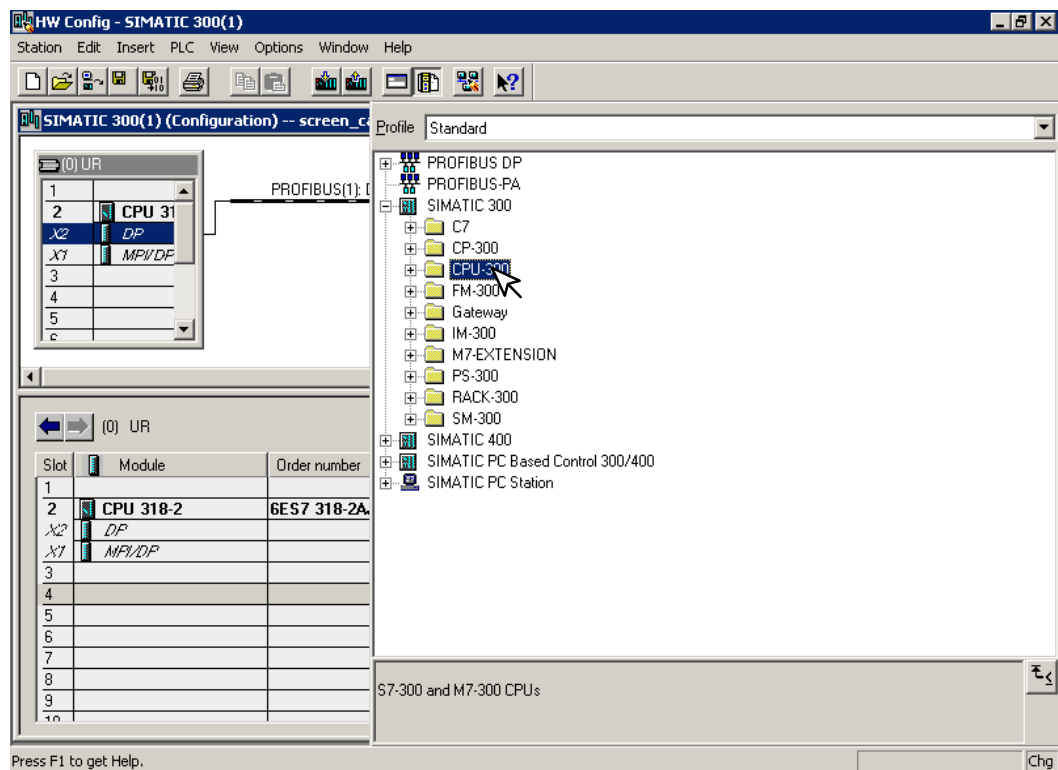

The GSD file will need to be installed now.

- Click on **Options** and select **Install New GSD...** in the drop-down window.

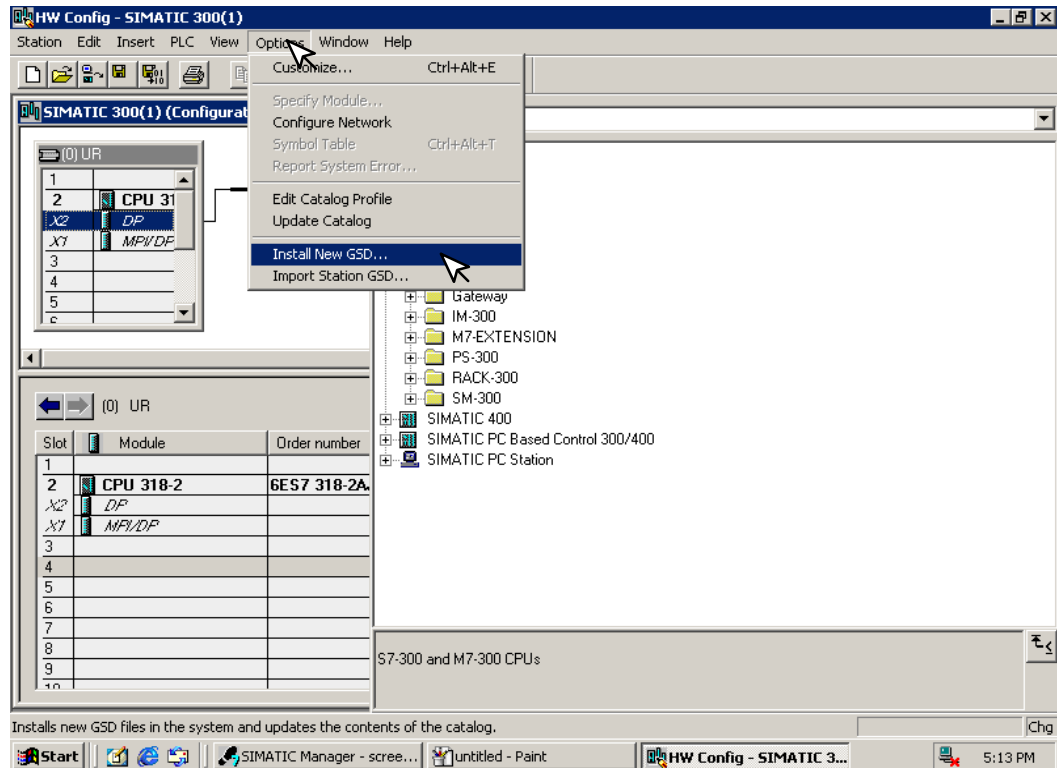

After installing the GSD file, the drop-down window will show the name of the newly loaded file.

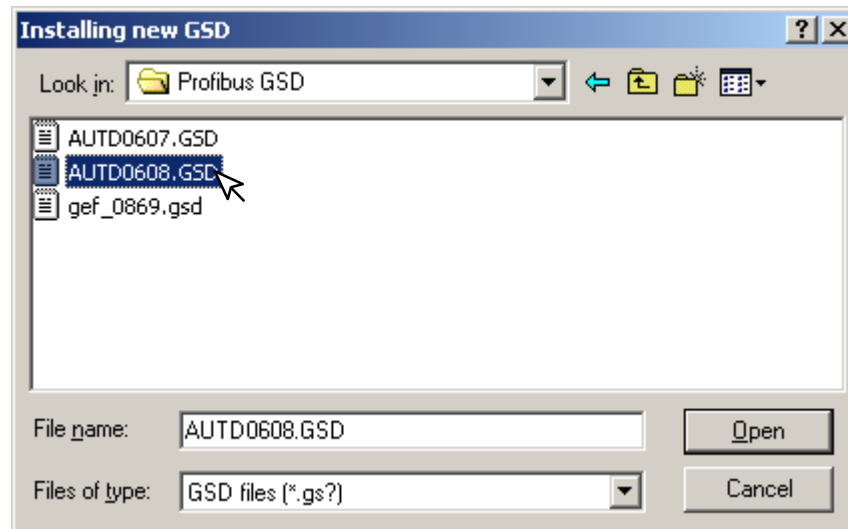

The Configuration window will look like the one below.

6. Now, click on the H2-PBC and drag it to the Profibus network.

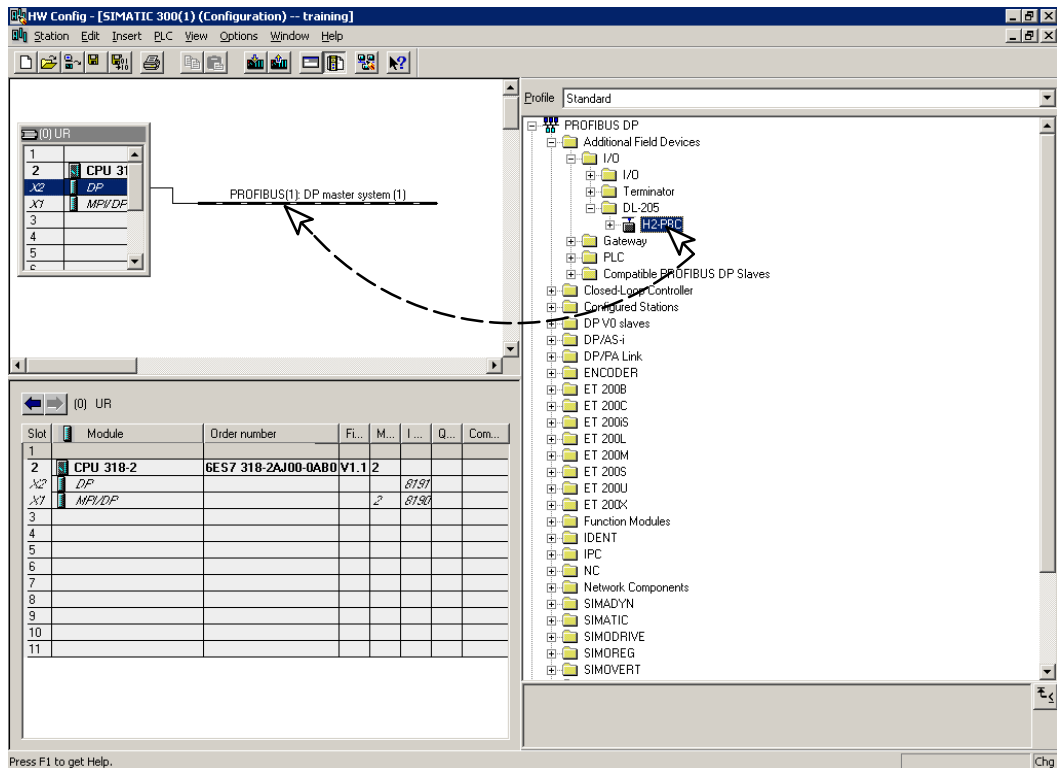

When the mouse button is released at the network node, the **Properties** window will appear so the correct node address can be entered. The transmission baud rate can be changed at this time also. Click **OK** when finished.

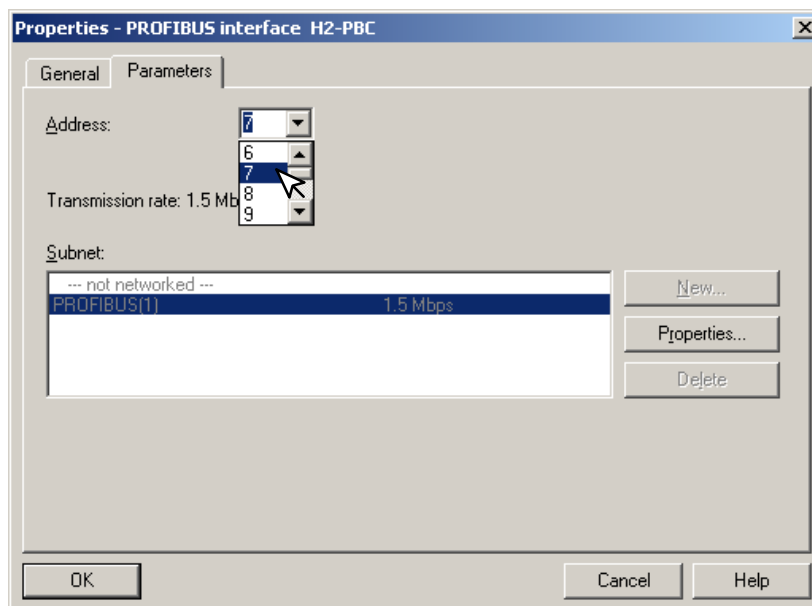

Now that the H2-PBC is a node on the Profibus network, the Terminator I/O needs to be added to the DP Base Controller.

7. Open the H2-PBC configuration window by clicking on H2-PBC at the node.

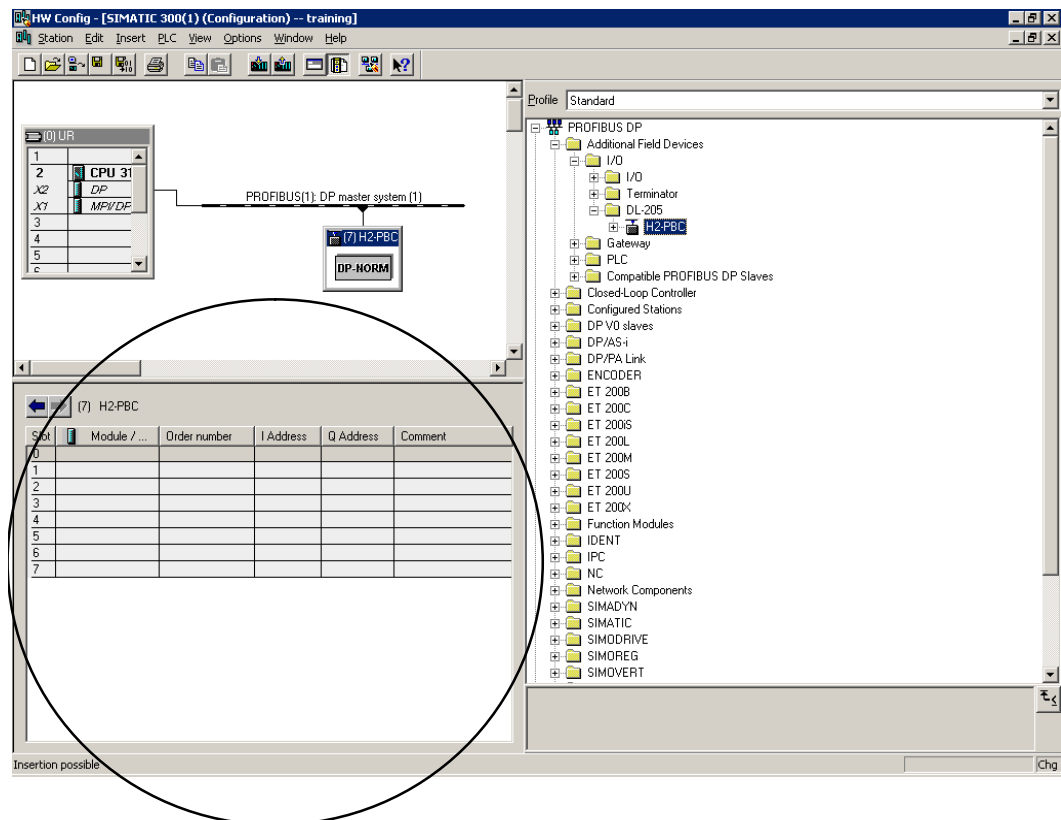

Open the H2-PBC I/O list by clicking on the + sign next to H2-PBC. Now you can choose the I/O modules which are installed in your Terminator base. You have the option of selecting the generic I/O or the Terminator I/O part number. The generic name is selected in this example.

8. Either click on the I/O name that you want and drag it to the configuration table to the left or double click on the I/O name and it will automatically go to the configuration list.

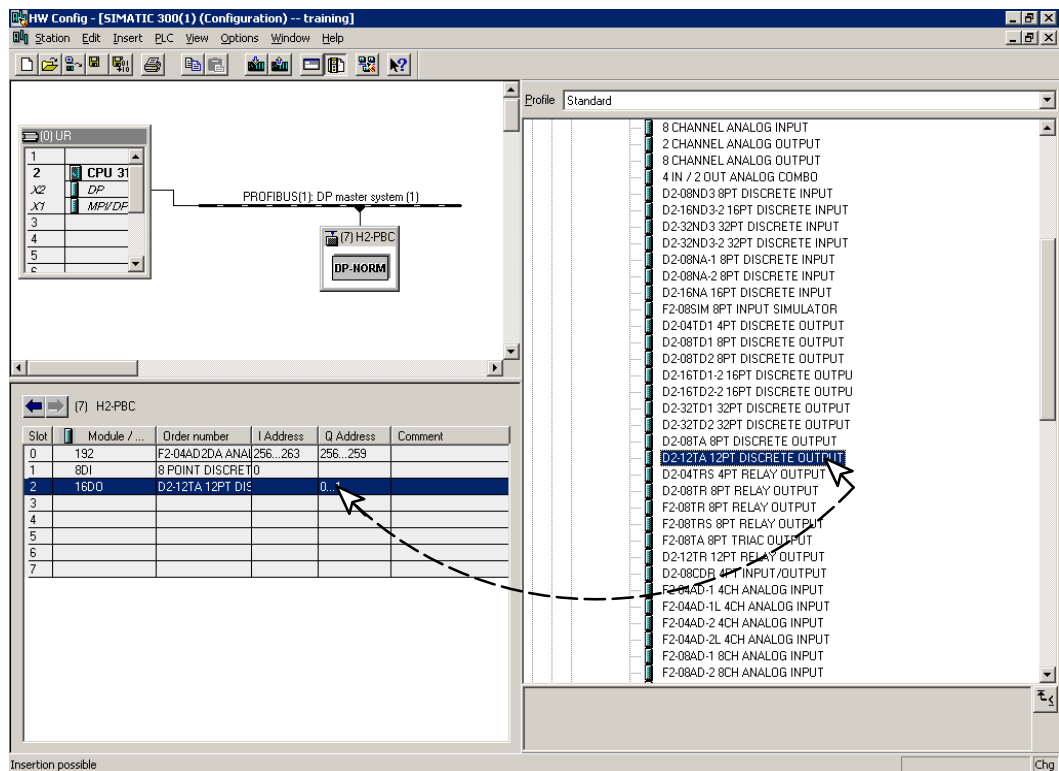

After you have finished configuring the I/O for the H2-PBC DP Slave, the configuration window will look like the example below.

The screenshot shows the HW Config window for a SIMATIC 300(1) system. The rack configuration is as follows:

Slot	Module
1	CPU 31
X2	DP
X1	MP/DP
3	
4	
5	
c	

The H2-PBC DP-NORM module is connected to the PROFIBUS DP master system (1). Below the rack configuration, the H2-PBC DP-NORM module configuration table is displayed:

Slot	Module / ...	Order number	I Address	Q Address	Comment
0	192	F2-04AD-2DA-ANA	256...263	256...259	
1	8DI	8 POINT DISCRETI			
2	16DO	D2-12TA-12PT DIS		0...1	
3					
4					
5					
6					
7					

8. Now, click on **Station**, then click on **Save and Compile** update your project. This will save the project for downloading to the PLC.

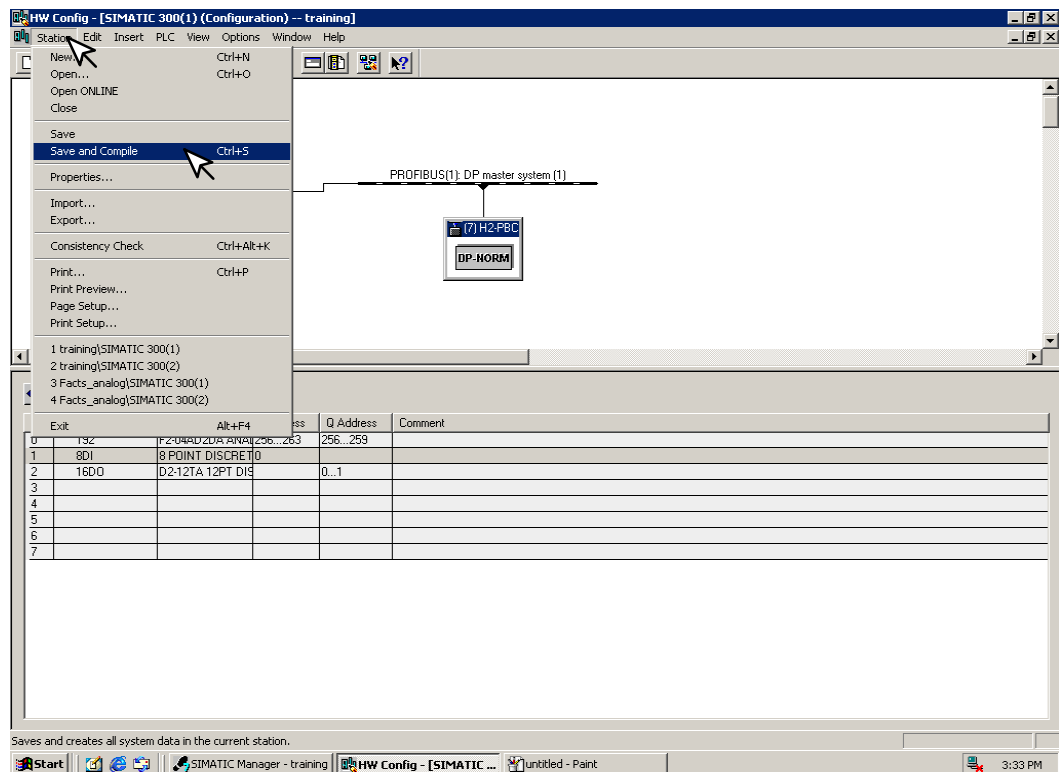

9. Select **PLC** and **Download...** the hardware setup that was saved.

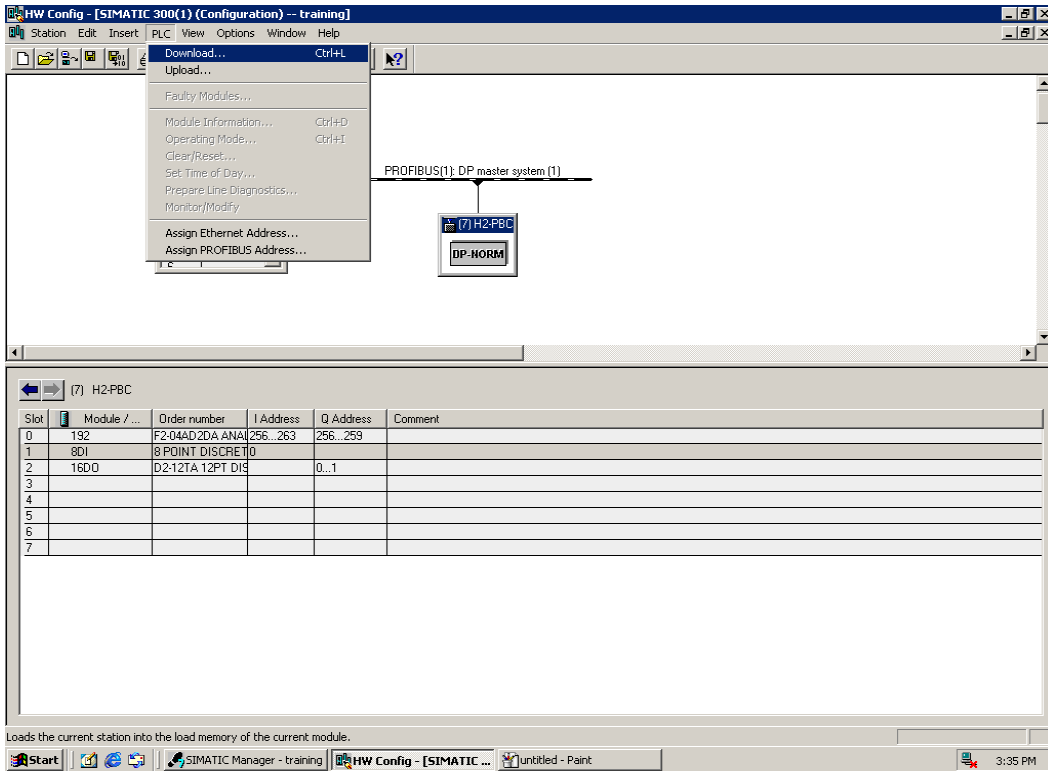

H2–PBC Extended Diagnostics Error Format

In This Appendix. . . .

— Extended Diagnostics Error Format

Profibus Extended Diagnostics Error Format

Byte	Values	Description
0	3–238	Number of bytes of error information (including this one)
1	0–255	PBC Module Error 0 = no error
2	0–58	Number of Error Groups following this byte Each Error Group contains 4 bytes: –Slot Number –Channel Number –Error Type –Error Value
Error Group Definition		
3	0–7	Slot Number of the module with the error
4	0–255	Channel Number of the module with the error 255 = All channels (i.e. entire module)
5	0–255	Error Type 0 = Normal error (Error Value found in next byte); 1 = Module bitwise error (Error Value contains a module specific bitwise value. See module's user manual.) 2 = Channel bitwise error (Error Value contains a module specific channel bitwise error. See module's user manual.)
6	0–255	Error Value If Error Type = 0, then: 1 = Module that was present no longer responds 2 = New module has been found 3 = General module error 4 = Channel failure error 5–255 = Undefined If Error Type = 1, then see module's user manual If Error Type = 2, then see module's user manual
2nd Group (4 more bytes, if called for)...etc.		

-
-
-

58th Group (4 more bytes, if called for)