

# Analog Input Modules

## P3-08RTD



### RTD Analog Input

The P3-08RTD input module provides eight differential channels for receiving RTD and resistance input signals.



Patent-pending LCD gives access to field signal values, as well as module and signal faults.



Terminal Block P3-RTB and Cover included. Not compatible with Z/PLink.

### RTD Input Specifications

Input Channels	8 Differential
Max. Common Mode Voltage	5VDC
Data Format	Floating Point
Common Mode Rejection	-90dB min. @ DC, -150dB min. @ 50/60Hz
Absolute Maximum Ratings	Fault protected input, ±50V
Internal Resolution	16 bit, ± 0.1°C or °F (up to 100 Hz filter)
Input Ranges (RTD Types)	Pt100 -200°C/850°C (-328°F/1562°F) Pt1000 -200°C/595°C (-328°F/1103°F) JPt100 -100°C/450°C (-148°F/ 842°F) 10Ω Cu. -200°C/260°C (-328°F/ 500°F) 25Ω Cu. -200°C/260°C (-328°F/ 500°F) 120Ω Ni. -80°C/260°C (-112°F/ 500°F)
RTD Linearization	Automatic
Excitation Current (all ranges)	200µA
Accuracy vs. Temperature	±5ppm per °C (maximum)
Full Scale Calibration	±1°C
Offset Calibration Error	±1 count (negligible)
Linearity Error (end to end)	±0.5°C maximum, ±0.01°C typical, Monotonic with no missing codes
Maximum Inaccuracy	±1°C maximum (excluding RTD error) (including temperature drift)
Warm-up Time	2 minutes for ±0.2% repeatability
Sample Duration (Single channel update rate)	Dependent on Digital Filter Settings -- 488ms @ 10Hz, 88ms @ 50 Hz, 75ms @ 60Hz, 56ms @ 100Hz, 48ms @ 250Hz
Filter Characteristics	Digital filter cutoff frequencies: 10Hz, 50Hz, 60Hz, 100Hz, or 250Hz
All Channel Update Rate	Single channel update rate times the number of enabled channels
Open Circuit Detection Time	Positive full scale reading within 2s
Conversion Method	Sigma-Delta
External DC Power Required	None

### Resistance Input Specifications

Internal Resolution	16 bit, .0015% of full scale range in ohms (up to 100Hz filter)
Resistance Input Ranges and PAC Resolution	0-10,000Ω, Resolution 1Ω 0-6,250Ω, Resolution 0.1Ω 0-3,125Ω, Resolution 0.1Ω 0-1,562.5Ω, Resolution 0.1Ω 0-781.25Ω, Resolution 0.1Ω 0-390.625Ω, Resolution .01Ω 0-195.3125Ω, Resolution .01Ω
Accuracy vs. Temperature	±25ppm per °C (maximum)
Full Scale Calibration	± .02% of full scale range
Offset Calibration Error	± .0015% of full scale range in ohms
Linearity Error (end to end)	± .0015% of full scale range maximum at 25°C, Monotonic with no missing codes
Maximum Inaccuracy	± 0.10% of full scale range

### Removable Terminal Block Specifications

Description	Part No. P3-RTB; 20 screw terminals
Wire Range	22-14 AWG (0.324 to 2.08 sq. mm) Solid / stranded conductor 3/64 in. (1.2 mm) insulation maximum "USE COPPER CONDUCTORS , 60°C" or equivalent.
Screw Driver Width	1/4 inch (6.5 mm) maximum
Screw Size	M3 size
Screw Torque	Field terminals – 7 - 9 in./lb (.0882 - 1.02 Nm) Self-jacking screws – 2.7 - 3.6 in./lb (0.3 - 0.4 Nm). Do not overtighten screws when installing terminal block.

### Diagnostics

Module Diagnostics Failure	1 bit per module
Module Not Ready	1 bit per module
Channel Burn-out (RTD only)	1 bit per channel
Under-range (RTD only)	1 bit per channel
Over-range	1 bit per channel

# Analog Input Modules

## P3-08RTD (cont'd)

General Specifications	
Operating Temperature	0° to 60°C (32° to 140°F)
Storage Temperature	-20° to 70°C (-4° to 158°F)
Humidity	5 to 95% (non-condensing)
Environmental Air	No corrosive gases permitted
Vibration	IEC60068-2-6 (Test Fc)
Shock	IEC60068-2-27 (Test Ea)
Field to Logic Side Isolation	1800VAC applied for 1 second
Insulation Resistance	>10MΩ @ 500 VDC
Heat Dissipation	0.33 W
Enclosure Type	Open Equipment
Agency Approvals	UL508 file E157382, Canada & USA UL1604 file E200031, Canada & USA CE (EN61131-2*) This equipment is suitable for use in Class 1, Division 2, Groups A, B, C and D or non-hazardous locations only.
Module Keying to Backplane	Electronic
Module Location	Any I/O slot in any local, expansion, or remote base in a Productivity3000 System.
Field Wiring	Removable terminal block (included). The P3-08RTD module is not compatible with the ZIPLink wiring system.
EU Directive	See the "EU Directive" topic in the Productivity3000 Help File. Information can also be obtained at: <a href="http://www.productivitypac.com">www.productivitypac.com</a>
Terminal Type	20-position removable terminal block (included)
Weight	107.8g (3.79 oz)

\*Meets EMC and Safety requirements. See the Declaration of Conformity for details.

**WARNING: Explosion hazard – Substitution of components may impair suitability for Class I, Division 2.**

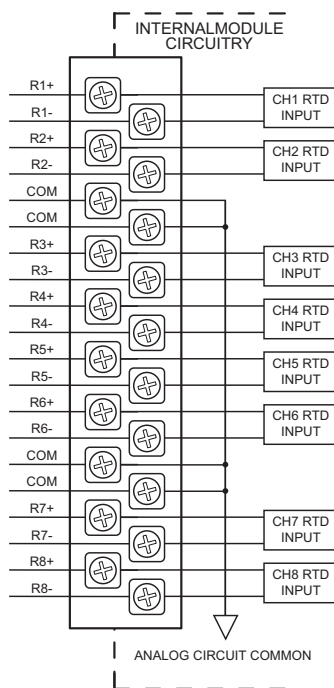

### Resistance Input

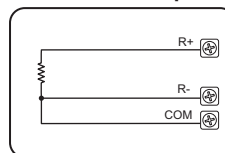

### RTD Input Circuits

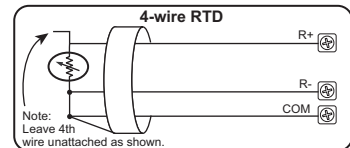
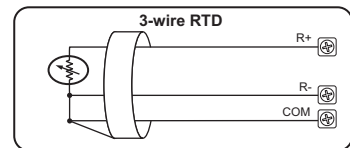
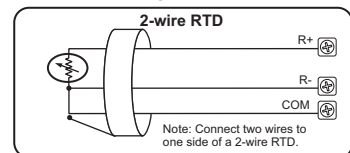

Notes for maximum accuracy:

1. For 2-wire RTD, attach third wire to module common.
2. R+, R-, and COM wires to an RTD must be equal length and type. Refer to RTD manufacturer's recommendations.
3. Do not use cable shield as sensing wire.
4. When applicable, connect shield to RTD common only, otherwise connect to module common only. Do not connect shield to both ends.
5. Jumper unused inputs to common.



# I/O Modules

A variety of discrete and analog I/O modules are available for use in local, expansion, and remote I/O bases. Specifications for each module are on the following pages.

A filler module is available for unused I/O module slots (part number P3-FILL).



## Discrete Input Modules

Productivity3000 Discrete Input Modules			
Part Number	Number of Inputs	Description	Price
P3-16SIM	16	Input Simulator Module	<-->
P3-08ND3S	8	Isolated Sinking/Sourcing DC Input	<-->
P3-16ND3	16	Sinking/Sourcing DC Input	<-->
P3-32ND3*	32	Sinking/Sourcing DC Input	<-->
P3-64ND3*	64	Sinking/Sourcing DC Input	<-->
P3-08NAS	8	Isolated AC Input	<-->
P3-16NA	16	AC Input	<-->

\*ZIPLink required.

## Analog I/O Modules

Productivity3000 Analog Input Modules			
Part Number	Number of Channels	Description	Price
P3-04ADS	4	Isolated Analog Input	<-->
P3-08AD	8	Analog Input	<-->
P3-16AD-1	16	Analog Input (Current)	<-->
P3-16AD-2	16	Analog Input (Voltage)	<-->
P3-08RTD	8	Analog RTD Input	<-->
P3-08THM	8	Analog Thermocouple Input	<-->

Productivity3000 Analog Output Modules			
Part Number	Number of Channels	Description	Price
P3-04DA	4	Analog Output	<-->
P3-08DA-1	8	Analog Output (Current)	<-->
P3-08DA-2	8	Analog Output (Voltage)	<-->
P3-06DAS-1	6	Isolated Analog Output (Current)	<-->
P3-06DAS-2	6	Isolated Analog Output (Voltage)	<-->
P3-16DA-1	16	Analog Output (Current)	<-->
P3-16DA-2	16	Analog Output (Voltage)	<-->

Productivity3000 Analog Input/Output Modules			
Part Number	Number of Channels	Description	Price
P3-8AD4DA-1	8/4	Analog Input/Output (Current)	<-->
P3-8AD4DA-2	8/4	Analog Input/Output (Voltage)	<-->

## Discrete Output Modules

Productivity3000 Discrete Output Modules			
Part Number	Number of Outputs	Description	Price
P3-08TD1S	8	Isolated Sinking Output	<-->
P3-08TD2S	8	Isolated Sourcing Output	<-->
P3-16TD1	16	Sinking Output	<-->
P3-16TD2	16	Sourcing Output	<-->
P3-32TD1*	32	Sinking Output	<-->
P3-32TD2*	32	Sourcing Output	<-->
P3-64TD1*	64	Sinking Output	<-->
P3-64TD2*	64	Sourcing Output	<-->
P3-08TAS	8	Isolated AC Output	<-->
P3-16TA	16	AC Output	<-->
P3-08TRS	8	Isolated Relay Output	<-->
P3-16TR	16	Relay Output	<-->
P3-08TRS-1	8	Isolated Relay Output	<-->

\*ZIPLink required.

## Module Installation Procedure

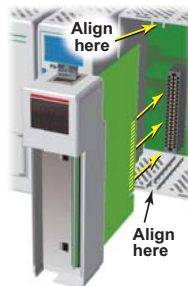

**WARNING:** Do not apply field power until the following steps are completed. See hot-swapping procedure for exceptions.

**Step One:** Align circuit card with slot and press firmly to seat module into connector.

**Step Two:** Pull top and bottom locking tabs toward module face. Click indicates lock is engaged.

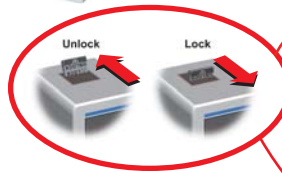

**Step Three:** Attach field wiring using optional terminal block or ZIPLink wiring system and install cover.



To install or remove terminal block cover, press middle to flex cover.



**WARNING:** Explosion hazard – Do not connect or disconnect connectors or operate switches while circuit is live unless the area is known to be non-hazardous. Do not hot-swap modules unless the area is known to be non-hazardous.