

P3-550 CPU Module

P3-550 <--->

The P3-550 is a full-featured, high-performance CPU. Features include a 4 line x 10 character LCD and seven communications ports which support USB, Ethernet and serial devices.

Each Productivity3000 system requires one CPU module mounted in the controller slot in the first base of the local base group. The CPU stores and executes the user's program.

The system can be expanded with the P3-RS or P3-EX modules. The local, expansion, and remote I/O are assigned preconfigured or user-defined tag names which can be easily referenced in the ladder logic program.

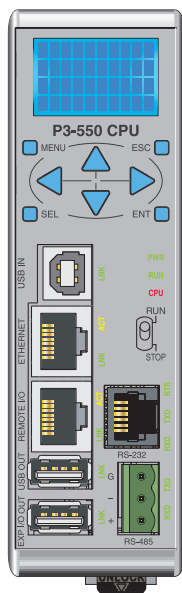

USB 2.0 (Type B) Port
- Programming
- Online monitoring

10/100 MB Ethernet Port
- Programming
- Online monitoring
- Email (SMTP client)
- Modbus TCP Client and Server

Local Ethernet Network
- GS Series drives
- Remote IO

USB 2.0 (Type A) Port
- USB Flash Drive data logger
- Project Transfer

USB 2.0 (Type A) Port
Local expansion bases
(connect up to 4 expansion) bases per base group

LCD
- 4 x 10 character
- 8 control buttons
- User defined messages
- User adjustable settings
- PAC system errors / information

CPU Status Indicators

RS-232 Serial Port (RJ12)
- Modbus/ASCII (master or slave) peripheral device

RS-485 Serial Port (TB Style)
- Modbus/ASCII (master peripheral device or multiple slave devices) using the same protocol

CPU Status Indicators

PWR	Green LED is illuminated when power is on
RUN	Green LED is illuminated when CPU is in RUN mode
CPU	Red LED is illuminated during power on reset, power down, or watch-dog time-out.



CPU Run/Stop Switch

RUN position	Executes user program, run-time edits possible
STOP position	Does not execute user program, normal program load position

P3-550 CPU Module

LCD Message Display

The CPU incorporates a 4 line x 10 character LCD Display for system alarms and information or for displaying user-defined messages.

LCD control buttons located beneath the display allow the user to navigate through a menu, and arrow buttons allow for configuration of time and date settings.

For user-defined messages, the display is configured using the Productivity Suite Programming Software. An LCD Page instruction allows the user to program text into user-defined tags and display the messages based on the ladder execution.

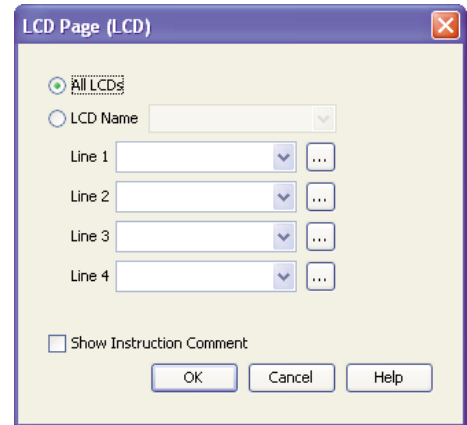

Specifications

CPU Specifications															
User Memory	50MB (Includes program, data and documentation)														
Memory Type	Flash and Battery Backed RAM														
Scan Time	600µs (3K Boolean, 1K I/O)														
Display	LCD, 4x10 characters, backlit, 8 control buttons; LCD characters are 5x7 with a dot pitch of 0.45mm; 2.25mm x 3.15mm														
Communications; 7 Integrated Ports	USB IN: Programming, Monitoring, Debug, Firmware ETHERNET: (10/100Mbps Ethernet) Programming, Monitoring, Debug, Firmware, Email SMTP Client, Modbus TCP Master (64 Slaves) and Slave (8 Masters) REMOTE I/O: (10/100Mbps Ethernet) 32 P3-RS Remote Base Groups, and 64 GS-EDRV (GS Drives) USB OUT: (2.0) Data Logging or Project Transfer using SDCZ4-2048-A10 Pen Drive EXP I/O OUT: (2.0 Proprietary) 4 P3-EX Local Expansion Bases RS-232: (RJ12, 1200-115.2k Baud) ASCII, Modbus RS-485: Removable Terminal Included, (1200-115.2k Baud) ASCII, Modbus														
Hardware Limits of System	33 Base Groups 1 Local (P3-550) + 32 Remote (P3-RS) 5 Bases per Base Group 1 P3-550 or P3-RS + 4 Expansion (P3-EX) 165 Bases Total 1 P3-550, 32 P3-RS, & 132 P3-EX 116,160 Hardware I/O Points (All 64-point I/O Modules) 64 GS Series Drives as Remote I/O														
Instruction Types	<table border="0"> <tr> <td>Application Functions</td> <td>PID</td> </tr> <tr> <td>Array Functions</td> <td>Program Control</td> </tr> <tr> <td>Counters/Timers</td> <td>String Functions</td> </tr> <tr> <td>Communications</td> <td>System Functions</td> </tr> <tr> <td>Data Handling</td> <td>Contacts</td> </tr> <tr> <td>Drum Sequencers</td> <td>Coil</td> </tr> <tr> <td>Math Functions</td> <td></td> </tr> </table>	Application Functions	PID	Array Functions	Program Control	Counters/Timers	String Functions	Communications	System Functions	Data Handling	Contacts	Drum Sequencers	Coil	Math Functions	
Application Functions	PID														
Array Functions	Program Control														
Counters/Timers	String Functions														
Communications	System Functions														
Data Handling	Contacts														
Drum Sequencers	Coil														
Math Functions															

General Specifications	
Operating Temperature	0° to 60°C (32° to 140°F)
Storage Temperature	-20° to 70°C (-4° to 158°F)
Humidity	5 to 95% (non-condensing)
Environmental Air	No corrosive gases permitted
Vibration	IEC60068-2-6 (Test Fc)
Shock	IEC60068-2-27 (Test Ea)
Heat Dissipation	7W
Enclosure Type	Open Equipment
Agency Approvals	UL508 file E157382, Canada & USA UL1604 file E200031, Canada & USA CE (EN61131-2*) This equipment is suitable for use in Class 1, Division 2, Groups A, B, C and D or non-hazardous locations only.
Module Location	Controller slot in the local base in a Productivity3000 System
EU Directive	See the "EU Directive" topic in the Productivity3000 Help File. Information can also be obtained at: www.productivitypac.com
Weight	260g (9 oz)

*Meets EMC and Safety requirements. See the Declaration of Conformity for details.

IMPORTANT!



Hot-Swapping Information

Note: This device cannot be Hot Swapped.

P3-550 CPU Module

Battery (Optional)

A battery is included with the P3-550 CPU, but is not installed. The battery can be installed to retain the Time and Date along with any Tagname values that are set up as retentive.

The battery is not needed for program backup.

Step One:

Press spring lock and swing battery compartment away from CPU.



Step Two

Insert battery and close compartment.

Battery (Optional)

D2-BAT-1

Coin type, 3.0V Lithium battery, 560mA, battery number CR2354

CPU Installation



Step One:

Locate the two sockets next to the power supply; the CPU will be inserted into this location.



Step Two:

Insert the CPU at a 45° angle into the notch located at the top of the base and rotate down until seated.



Step Three:

Snap retaining tab into the locked position.

WARNING: Explosion hazard – Do not connect or disconnect connectors or operate switches while circuit is live unless the area is known to be non-hazardous. Do not hot swap.

P3-550 CPU Module - Communications

Port Specifications

The P3-550 CPU has seven communications ports. The following pages list specifications and pin-out diagrams for these ports.

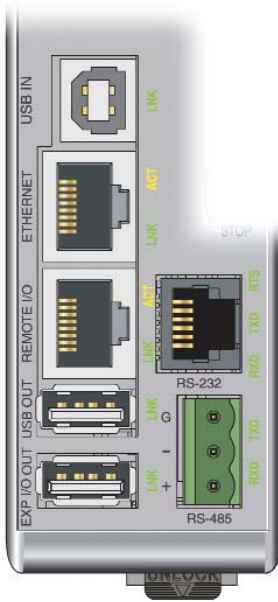

USB IN Port

Used exclusively for connecting to a PC running the Productivity Suite programming software.

USB Type B Slave Input Specifications	
Port Name	USB IN
Description	Standard USB 2.0 Slave input for programming and online monitoring, with built-in surge protection. Not compatible with older full speed USB devices.
Transfer Rate	480 Mbps
Port Status LED	Green LED is illuminated when LINK is established to programming software.
Cables	USB Type A to USB Type B: 3 ft. cable part # USB-CBL-AB3 6 ft. cable part # USB-CBL-AB6 10 ft. cable part # USB-CBL-AB10 15 ft. cable part # USB-CBL-AB15

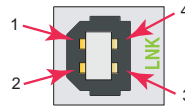

Mating face of USB type B female

Pin #	Signal
1	+5
2	-Data
3	+Data
4	GND

Ethernet Port

RJ-45 style connector used for:

- Connection to a PC running the Productivity Suite programming software
- Modbus TCP Client connections (Modbus requests sent from the P3-550)
- Modbus TCP Server connections (Modbus requests received by the P3-550)
- Outgoing E-mail

Remote I/O Port

RJ-45 style connector used for connecting to a Remote I/O network consisting of P3-RS Remote Slaves and/or GS-EDRV units with GS drives.

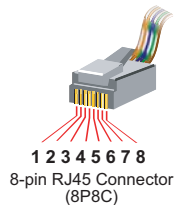
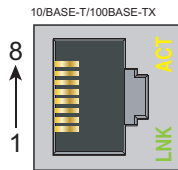
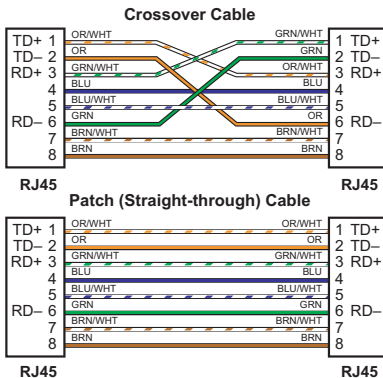

Ethernet Specifications		
Port Name	ETHERNET	REMOTE I/O
Description	Standard transformer isolated Ethernet port with built-in surge protection for programming, online monitoring, Email (SMTP client) and Modbus/TCP client/server connections (fixed IP or DHCP).	Standard transformer isolated Ethernet port with built-in surge protection for connection to the P3-RS Remote I/O system. Supports 32 Remote I/O slaves and 64 GS Series drives.
Transfer Rate	10/100 Mbps	
Port Status LED	Green LED illuminated when network LINK is established. Yellow LED is illuminated when port is active (ACT).	
Cables	Use a Patch (straight through) cable when a switch or hub is used. Use a Crossover cable (not offered by ADC) when a switch or hub is not used.	

P3-550 CPU Module - Communications

Port Specifications

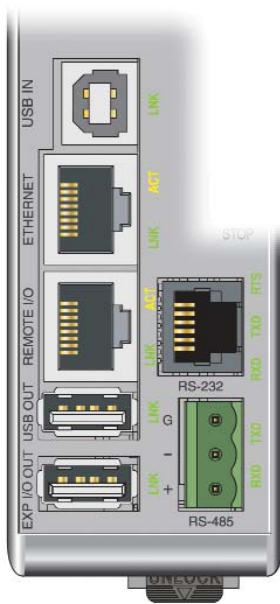

USB OUT Port

Used for data logging or project transfers to and from a SDCZ4-2048-A10 Pen Drive.

EXP I/O OUT Port

USB port used only for Expansion I/O connections to local P3-EX modules in a Productivity3000 base with I/O.

USB Type A Master Output Specifications

Port Name	USB OUT	EXP I/O OUT
Description	Standard USB 2.0 Master output for connection to high-speed Flash drive (Sandisk SDCZ4-2048-A10) for data logging or program transfer with built-in surge protection. Not compatible with older full speed USB devices. A 0.5m male-to-female "port extender" cable is included to assist with Flash drive connection.	Proprietary USB 2.0 Master output for connection with up to four P3-EX local expansion bases, with built-in surge protection.
Transfer Rate	480 Mbps	
Port Status LED	Green LED is illuminated when LINK is established to connected device	
Cables	None required	USB Type A to USB Type B: 6 ft. cable part # P3-EX-CBL6 (included with P3-EX module)

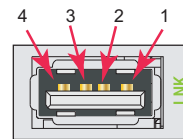

Mating face of USB type A female

USB OUT

Pin #	Signal
1	+5
2	- Data
3	+ Data
4	GND

EXP I/O OUT

Pin #	Signal
1	Reset
2	- Data
3	+ Data
4	GND

RS-232 Port

RJ-12 style connector used for:

- Modbus RTU Master connections
- Modbus RTU Slave connections
- ASCII Incoming and Outgoing communications
- Custom Protocol Incoming and Outgoing communications

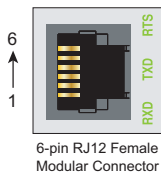

Pin #	Signal
1	GND Logic Ground
2	+5V 210 mA Maximum
3	RXD RS-232 Input
4	TXD RS-232 Output
5	RTS RS-232 Output
6	GND Logic Ground

RS-232 Specifications

Port Name	RS-232
Description	Non-isolated RS-232 DTE port connects the CPU as a Modbus/ASCII master or slave to a peripheral device. Includes ESD and built-in surge protection.
Data Rates	Selectable, 1200, 2400, 9600, 19200, 33600, 38400, 57600, and 115200.
+5V Cable Power Source	210mA maximum at 5V, +/- 5%. Reverse polarity and overload protected.
TXD	RS-232 Transmit output
RXD	RS-232 Receive input
RTS	Handshaking output for modem control.
GND	Logic ground
Maximum Output Load (TXD/RTS)	3K Ω , 1,000pf
Minimum Output Voltage Swing	+/-5V
Output Short Circuit Protection	+/-15mA
Port Status LED	Green LED is illuminated when active for TXD, RXD and RTS
Cable Options	D2-DSCBL USB-RS232 with D2-DSCBL FA-CABKIT FA-ISOCAN for converting RS-232 to isolated RS-485

P3-550 CPU Module - Communications

Port Specifications

RS-485 Port

A 3-pin removable terminal block used for:

- Modbus RTU Master connections
- Modbus RTU Slave connections
- ASCII Incoming and Outgoing communications
- Custom Protocol Incoming and Outgoing communications

Removable connector included. Spare connectors available (part no. P3-RS485CON).

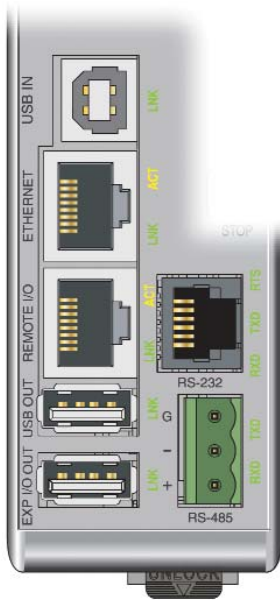

RS-485 Port Specifications	
Port Name	RS-485
Description	Non-isolated RS-485 port connects the CPU as a Modbus/ASCII master or slave to a peripheral device. Includes ESD/EFT protection and automatic echo cancellation when transmitter is active.
Data Rates	Selectable, 1200, 2400, 9600, 19200, 33600, 38400, 57600, and 115200.
TXD+/RXD+	RS-485 transceiver high
TXD-/RXD-	RS-485 transceiver low
GND	Logic ground
Input Impedance	19K Ω
Maximum load	50 transceivers, 19K Ω each, 60 Ω termination
Output Short Circuit Protection	+/- 250mA, thermal shut-down protection
Electrostatic Discharge Protection	+/-8KV per IEC1000-4-2
Electrical Fast Transient Protection	+/-2KV per IEC1000-4-4.
Minimum Differential Output Voltage	1.5V with 60 Ω load
Fail safe inputs	Logic high input state if inputs are unconnected
Maximum Common Mode Voltage	-7.5V to 12.5V.
Port Status LED	Green LED illuminated when active for TXD and RXD
Cable Options	Recommend Belden #9841 or equivalent

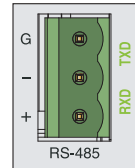
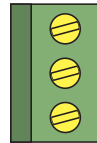

Pin #	Signal
G	GND
-	TXD-/RXD-
+	TXD+/RXD+

Removable connector included. Spare connectors available (part no. P3-RS485CON).