

Analog Input/Output Modules

P3-8AD4DA-2 <---->

Voltage Analog Input/Output

The P3-8AD4DA-2 Voltage Analog Input/Output Module provides eight channels of 0-5 VDC and 0-10 VDC inputs and four channels of 0-5 VDC and 0-10 VDC outputs.



Patent-pending LCD gives access to field signal values, as well as module and signal faults.

Terminal block sold separately; terminal block cover included with module.

Removable Terminal Block Specifications

Description	Part No. P3-RTB; 20 screw terminals
Wire Range	22-14 AWG (0.324 to 2.08 sq. mm) Solid / stranded conductor 3/64 in. (1.2 mm) insulation maximum "USE COPPER CONDUCTORS , 60°C" or equivalent.
Screw Driver Width	1/4 inch (6.5 mm) maximum
Screw Size	M3 size
Screw Torque	Field terminals – 7 - 9 in./lb (.882 - 1.02 Nm) Self-jacking screws – 2.7 - 3.6 in./lb (0.3 - 0.4 Nm). Do not overtighten screws when installing terminal block.

We recommend using prewired ZIPLink cables and connection modules. See "Wiring Systems".

Terminal block cover included. If you wish to hand-wire your module, a removable terminal block is sold separately. Order part number P3-RTB.



Input Specifications

Input channels	8 inputs (1 common)
Input ranges	0 - 5V, 0 - 10V
Signal resolution	12-16 bit, depending on input resolution
0-5V Input Resolution & Update Rate <i>See Note 1</i>	Fine: 7.1ms, 76µV, 16 bit Medium: 1.78ms, 305µV, 14 bit Coarse: 444µs, 1.22mV, 12 bit
0-10V Input Resolution & Update Rate <i>See Note 1</i>	Fine: 7.1ms, 152µV, 16 bit Medium: 1.78ms, 610µV, 14 bit Coarse: 444µs, 2.44mV, 12 bit
Data Range	0 - 65535 counts
Maximum continuous overload	±100V, voltage input
Input impedance	1M Ω (± 10%) voltage input
Hardware Filter Characteristics	Low pass 1st order, -3dB @ 80Hz
All Channel Update Rate <i>See Note 2</i>	Fine: 56.8ms Medium: 14.24ms Coarse: 3.55ms
Conversion Method	Successive Approximation
Accuracy vs. Temperature	±15PPM / °C Maximum
Maximum Inaccuracy	0.1% of range
Linearity Error (end to end)	±0.015% of range maximum Monotonic with no missing codes
Input Stability and Repeatability	± 0.025% of range (after 10 min. warm up)
Full Scale Calibr. Error (minus offset)	±.05% of range maximum
Offset Calibration Error	±.05% of range maximum
Max Crosstalk	-96dB
External DC Power Required	24 VDC (-20% / + 25%), 90mA maximum

Note 1: The Input Resolution of Fine returns 16 bit resolution. Medium and Coarse are 14 and 12 bit respectively. The 12 and 14 bit input values are scaled to 0-65535.

Note 2: Valid when all channels are set for the same Input Resolution.

Output Specifications

Output channels	4 (1 common)
Output ranges	0 - 10V, 0 - 5V
Output Signal resolution	16-bit
Resolution Value of LSB (least significant bit)	0 - 5V = 76µV/count 0 - 10V = 152µV/count 1 LSB = 1 count
Data Range	0 - 65535 counts
Output Type	Voltage sourcing/sinking at 10mA max.
Output Value in Fault Mode	0V
Load Impedance	≥1125Ω
Maximum capacitive load	.01µF maximum
Allowed Load Type	Grounded
Maximum Inaccuracy	0.1% of range
Maximum Full Scale Calibration Error (not including offset error)	±0.065% of range maximum
Maximum Offset Calibration Error	±0.065% of range maximum
Accuracy vs. Temperature	±25 ppm/ °C maximum full scale calibration change (± 0.0025% of range / °C)
Max Crosstalk	-96 dB
Linearity Error (end to end)	0.015% of full scale Monotonic with no missing codes
Output Stability and Repeatability	±0.015% after 10 min. warm-up typical
Output Ripple	.01% of Full Scale at 50/60 Hz
Output Settling Time	0.5 ms max, 5 µs min (full scale change)
All Channel Update Rate	5ms
Maximum Continuous Overload	Outputs current limited to 15mA typical
Type of Output Protection	15VDC peak output voltage
Output Signal (power-up, -down)	0V

Analog Input/Output Modules

P3-8AD4DA-2 (cont'd)

General Specifications	
Operating Temperature	0° to 60°C (32° to 140°F)
Storage Temperature	-20° to 70°C (-4° to 158°F)
Humidity	5 to 95% (non-condensing)
Environmental Air	No corrosive gases permitted
Vibration	IEC60068-2-6 (Test Fc)
Shock	IEC60068-2-27 (Test Ea)
Field to Logic Side Isolation	1800VAC applied for 1 second
Insulation Resistance	>10MΩ @ 500 VDC
Heat Dissipation	2.5W
Enclosure Type	Open Equipment
Agency Approvals	UL508 file E157382, Canada & USA UL1604 file E200031, Canada & USA CE (EN61131-2*) This equipment is suitable for use in Class 1, Division 2, Groups A, B, C and D or non-hazardous locations only.
Module Keying to Backplane	Electronic
Module Location	Any I/O slot in any local, expansion, or remote base in a Productivity3000 System.
Field Wiring	Removable terminal block (not included). Use ZIPLink wiring system or optional terminal block. See "Wiring I/O Modules".
EU Directive	See the "EU Directive" topic in the Productivity3000 Help File. Information can also be obtained at: www.productivitypac.com
Terminal Type (not included)	20-position removable terminal block
Weight	105g (3.73 oz)

*Meets EMC and Safety requirements. See the Declaration of Conformity for details.

WARNING: Explosion hazard – Substitution of components may impair suitability for Class I, Division 2.

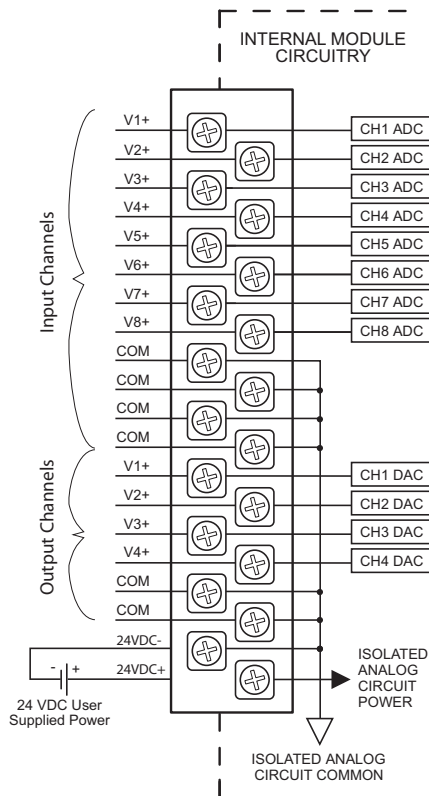

Voltage Input Circuits

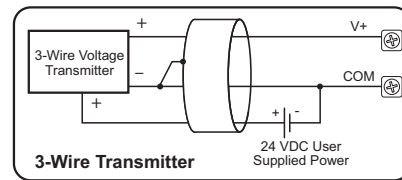
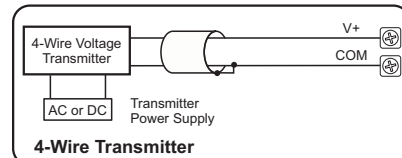

Voltage Output Circuits

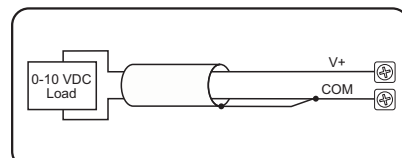
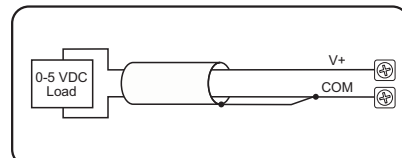

Note: This module includes input and output channels. Before connecting field wiring, verify that you are connecting to the appropriate terminals.



Specify your ZIPLink system

Use the Compatibility Matrix table below.

Step 1	Locate the I/O module part number.
Step 2	Locate Connector Module Type. (Feedthrough Module, Fuse Module, etc...)
Step 3	Select the cable length by replacing the # symbol with: Blank = 0.5m, -1 = 1.0m, -2 = 2.0m ¹
¹ Note: Cable part number denotes compatibility between Connector Module and I/O Modules.	

Productivity3000 ZIPLink Wiring System Compatibility Matrix								
Step 2: Connector Module Type		Feedthrough Modules		Fuse Modules		Relay Module	Sensor Input Mod.	Pigtail Cable
Step 1: I/O Module	Number of Terminals	ZL-RTB20	ZL-RTB40	ZL-RFU20	ZL-RFU40	ZL-RRL16-24	ZL-LTB16-24	
		Step 3: Cables						
Inputs								
P3-08NAS	20	ZL-P3-CBL20#						ZL-P3-CBL20-#P
P3-08ND3S	20	ZL-P3-CBL20#						ZL-P3-CBL20-#P
P3-16NA	20	ZL-P3-CBL20L#						ZL-P3-CBL20-#P
P3-16ND3	20	ZL-P3-CBL20L#						ZL-P3-CBL20-#P
P3-32ND3	40		ZL-CBL40#				ZL-P3-CBL40#	
P3-64ND3*	40		ZL-CBL40#				ZL-P3-CBL40#	
Outputs								
P3-08TAS	20	ZL-P3-CBL20#						ZL-P3-CBL20-#P
P3-08TD1S	20	ZL-P3-CBL20L#						ZL-P3-CBL20-#P
P3-08TD2S	20	ZL-P3-CBL20L#						ZL-P3-CBL20-#P
P3-08TRS	20	ZL-P3-CBL20#						ZL-P3-CBL20-#P
P3-16TA	20	ZL-P3-CBL20#		ZL-P3-CBL20L#				ZL-P3-CBL20-#P
P3-16TD1	20	ZL-P3-CBL20#		ZL-P3-CBL20#		ZL-P3-CBL20#		ZL-P3-CBL20-#P
P3-16TD2	20	ZL-P3-CBL20#		ZL-P3-CBL20#				ZL-P3-CBL20-#P
P3-16TR	20	ZL-P3-CBL20#		ZL-P3-CBL20#				ZL-P3-CBL20-#P
P3-08TRS-1***	20	ZL-P3-CBL20#						ZL-P3-CBL20-#P
P3-32TD1	40		ZL-CBL40#		ZL-CBL40#			
P3-32TD2	40		ZL-CBL40#		ZL-CBL40#			
P3-64TD1*	40		ZL-CBL40#		ZL-CBL40#			
P3-64TD2*	40		ZL-CBL40#		ZL-CBL40#			
Analog In								
P3-04ADS	20	ZL-P3-CBL20L#						ZL-P3-CBL20-#P
P3-08AD	20	ZL-P3-CBL20L#						ZL-P3-CBL20-#P
P3-16AD-1	20	ZL-P3-CBL20L#						ZL-P3-CBL20-#P
P3-16AD-2	20	ZL-P3-CBL20L#						ZL-P3-CBL20-#P
P3-08RTD**	Matched Only							
P3-08THM**	T/C Wire Only							
Analog Out								
P3-04DA	20	ZL-P3-CBL20L#						ZL-P3-CBL20-#P
P3-08DA-1	20	ZL-P3-CBL20L#						ZL-P3-CBL20-#P
P3-08DA-2	20	ZL-P3-CBL20L#						ZL-P3-CBL20-#P
P3-06DAS-1	20	ZL-P3-CBL20L#						ZL-P3-CBL20-#P
P3-06DAS-2	20	ZL-P3-CBL20L#						ZL-P3-CBL20-#P
P3-16DA-1	20	ZL-P3-CBL20L#						ZL-P3-CBL20-#P
P3-16DA-2	20	ZL-P3-CBL20L#						ZL-P3-CBL20-#P
Analog Combo								
P3-8AD4DA-1	20	ZL-P3-CBL20L#						ZL-P3-CBL20-#P
P3-8AD4DA-2	20	ZL-P3-CBL20L#						ZL-P3-CBL20-#P

*The P3-64ND3, P3-64TD1, and P3-64TD2 modules have two 32-point connectors and require 2 ZIPLink cables and 2 ZIPLink connector modules.

**These modules are not supported by the ZIPLink wiring system. Removable terminal block P3-RTB included.

***The P3-08TRS-1 output module is derated, not to exceed 2A per point maximum when used with the ZIPLink wiring system.

I/O Modules

A variety of discrete and analog I/O modules are available for use in local, expansion, and remote I/O bases. Specifications for each module are on the following pages.

A filler module is available for unused I/O module slots (part number P3-FILL).



Discrete Input Modules

Productivity3000 Discrete Input Modules			
Part Number	Number of Inputs	Description	Price
P3-16SIM	16	Input Simulator Module	<--->
P3-08ND3S	8	Isolated Sinking/Sourcing DC Input	<--->
P3-16ND3	16	Sinking/Sourcing DC Input	<--->
P3-32ND3*	32	Sinking/Sourcing DC Input	<--->
P3-64ND3*	64	Sinking/Sourcing DC Input	<--->
P3-08NAS	8	Isolated AC Input	<--->
P3-16NA	16	AC Input	<--->

*ZIPLink required.

Analog I/O Modules

Productivity3000 Analog Input Modules			
Part Number	Number of Channels	Description	Price
P3-04ADS	4	Isolated Analog Input	<--->
P3-08AD	8	Analog Input	<--->
P3-16AD-1	16	Analog Input (Current)	<--->
P3-16AD-2	16	Analog Input (Voltage)	<--->
P3-08RTD	8	Analog RTD Input	<--->
P3-08THM	8	Analog Thermocouple Input	<--->

Productivity3000 Analog Output Modules			
Part Number	Number of Channels	Description	Price
P3-04DA	4	Analog Output	<--->
P3-08DA-1	8	Analog Output (Current)	<--->
P3-08DA-2	8	Analog Output (Voltage)	<--->
P3-06DAS-1	6	Isolated Analog Output (Current)	<--->
P3-06DAS-2	6	Isolated Analog Output (Voltage)	<--->
P3-16DA-1	16	Analog Output (Current)	<--->
P3-16DA-2	16	Analog Output (Voltage)	<--->

Productivity3000 Analog Input/Output Modules			
Part Number	Number of Channels	Description	Price
P3-8AD4DA-1	8/4	Analog Input/Output (Current)	<--->
P3-8AD4DA-2	8/4	Analog Input/Output (Voltage)	<--->

Discrete Output Modules

Productivity3000 Discrete Output Modules			
Part Number	Number of Outputs	Description	Price
P3-08TD1S	8	Isolated Sinking Output	<--->
P3-08TD2S	8	Isolated Sourcing Output	<--->
P3-16TD1	16	Sinking Output	<--->
P3-16TD2	16	Sourcing Output	<--->
P3-32TD1*	32	Sinking Output	<--->
P3-32TD2*	32	Sourcing Output	<--->
P3-64TD1*	64	Sinking Output	<--->
P3-64TD2*	64	Sourcing Output	<--->
P3-08TAS	8	Isolated AC Output	<--->
P3-16TA	16	AC Output	<--->
P3-08TRS	8	Isolated Relay Output	<--->
P3-16TR	16	Relay Output	<--->
P3-08TRS-1	8	Isolated Relay Output	<--->

*ZIPLink required.

Module Installation Procedure

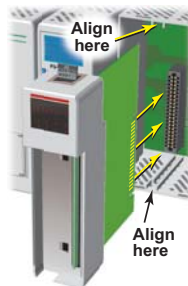

WARNING: Do not apply field power until the following steps are completed. See hot-swapping procedure for exceptions.

Step One: Align circuit card with slot and press firmly to seat module into connector.

Step Two: Pull top and bottom locking tabs toward module face. Click indicates lock is engaged.

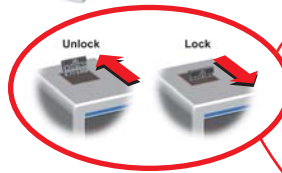

Step Three: Attach field wiring using optional terminal block or ZIPLink wiring system and install cover.



To install or remove terminal block cover, press middle to flex cover.



WARNING: Explosion hazard – Do not connect or disconnect connectors or operate switches while circuit is live unless the area is known to be non-hazardous. Do not hot-swap modules unless the area is known to be non-hazardous.