

# Analog Voltage Input Module

T1F-08AD-2 <---->

## 8-channel analog voltage input module

The 8-channel voltage input module uses a T1K-08B or T1K-08B-1 base, which is purchased separately.

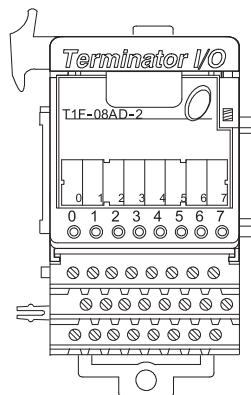

T1F-08AD-2 Analog Input Specification	
<b>Channels Per Module</b>	8 single-ended (1 common)
<b>Input Ranges</b>	0-5 V, 0-10 V, $\pm 5V$ , $\pm 10V$
<b>Resolution</b>	14 bit (13 bit plus sign bit)
<b>Frequency Response</b>	-3 db @ 500 Hz, -20 db/decade
<b>Input Resistance</b>	200 K $\Omega$ min.
<b>Absolute Max. Ratings</b>	Fault protected input 130 V(rms) or 100 VDC
<b>Conversion Time</b>	Normal mode: 5 ms per channel (default); Fast mode*: 0.5 ms per channel
<b>Linearity Error</b>	$\pm 2$ count max.
<b>Input Stability</b>	Normal mode: $\pm 1$ count (default); Fast mode*: $\pm 5$ counts
<b>Calibration Full Scale Error</b>	8 counts max.
<b>Calibration Offset Error</b>	2 counts max.
<b>Max. Full Scale Inaccuracy (% of full scale); All errors included</b>	0.08% @ 25°C 0.26% @ 60°C
<b>Master Update Rate</b>	8 channels per scan max.
<b>Input Points Required</b>	256 discrete pts. or 8 Dwords (32-bit words) (Network Interface Dependent)
<b>Base Power Required</b>	75 mA @ 5 VDC
<b>External Module Power Required</b>	21.6-26.4 VDC, 50 mA, class 2
<b>Weight</b>	136 g

\* Fast mode is supported in module hardware version B or later.  
Fast mode is only supported when using the analog module with the T1H-EBC(100) or T1H-PBC Interface module.

### Equivalent Input Circuit

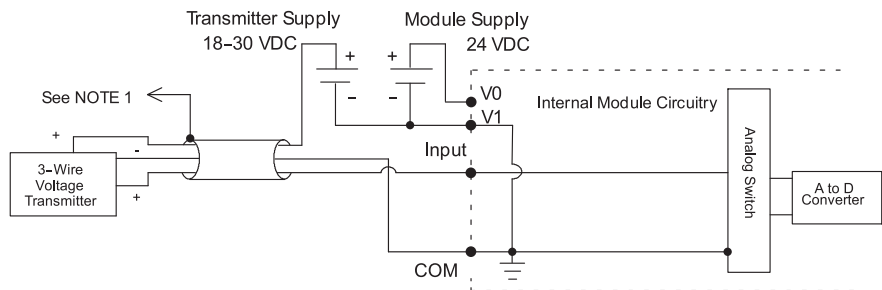

#### NOTES:

- 1: Shields should be grounded at the signal source.
- 2: Unused inputs should be connected to common (0 VDC).
- 3: More than one external power supply can be used, provided all the power supply commons are connected.

# Dimensions and Installation

It is important to understand the installation requirements for your Terminator I/O system. This will ensure that the Terminator I/O products work within their environmental and electrical limits.

## Plan for safety

This catalog should never be used as a replacement for the technical data sheet that comes with the products or the T1K-INST-M Installation and I/O Manual (available online at [www.automationdirect.com](http://www.automationdirect.com).) The technical data sheet contains information that must be followed. The system installation should comply with all appropriate electrical codes and standards.

## Unit dimensions and mounting orientation

Use the following diagrams to make sure the Terminator I/O system can be installed in your application. Terminator I/O units should be mounted horizontally. To ensure proper airflow for cooling purposes, units should not be mounted upside-down. It is important to check the Terminator I/O dimensions against the conditions required for your application. For example, it is recommended to leave 2" depth for ease of access and cable clearance. However, your distance may be greater or less. Also, check the installation guidelines for the recommended cabinet clearances.

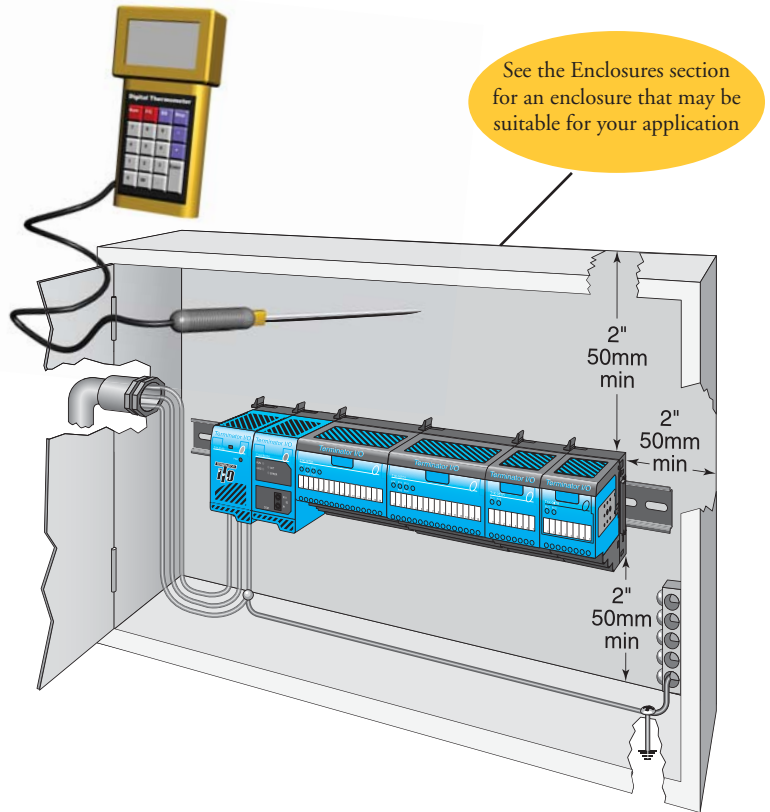

Terminator I/O Environmental Specifications	
<b>Ambient Operating Temperature</b>	32°F to 131°F (0°C to 55°C)
<b>Storage Temperature</b>	-4°F to 158°F (-20°C to 70°C)
<b>Ambient Humidity</b>	5% to 95% (Non-condensing)
<b>Atmosphere</b>	No corrosive gases. The level of environmental pollution = 2 (UL 840)
<b>Vibration Resistance</b>	MIL STD 810C, Method 514.2
<b>Shock Resistance</b>	MIL STD 810C, Method 516.2
<b>Voltage Withstand (Dielectric)</b>	1500 VAC, 1 minute
<b>Insulation Resistance</b>	500 VDC, 10 MΩ
<b>Noise Immunity</b>	NEMA ICS3-304 Impulse noise 1μs, 1000 V FCC class A RFI (144 MHz, 430 MHz 10 W, 10 cm)
<b>Agency Approvals</b>	UL, CE, FCC class A, NEC Class 1 Division 2

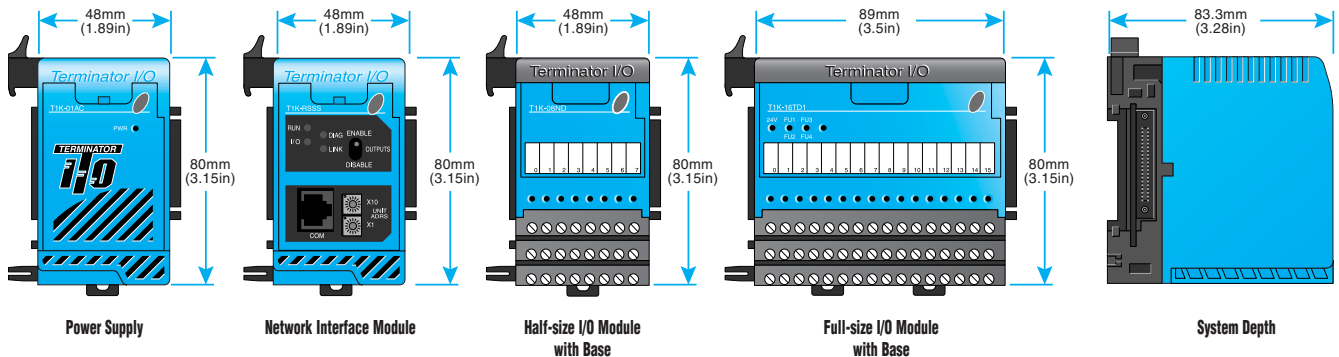

# I/O Module Installation

## I/O module installation

Terminator I/O modules feature separate terminal bases for easy installation.

To install I/O modules:

1. Slide the module into its terminal base (until it clicks into position)
2. Hook upper DIN rail tabs over the top of DIN rail, and press the assembly firmly onto the DIN rail.
3. Slide the module along the DIN rail until it engages with the adjacent module.

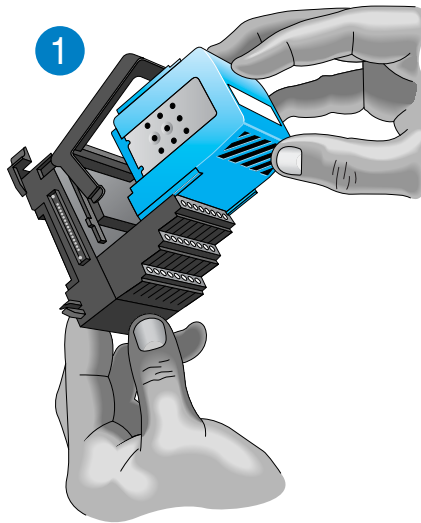

### DN-ASB-1 angled mounting bracket

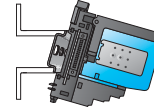
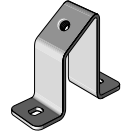

Great for mounting in upper locations

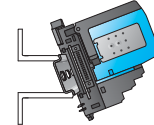

Great for mounting in lower locations

Optional angled support bracket raises and tilts the mounting rail for easier access and wiring. Use with 35 mm DIN rail. See the Connection Systems in this catalog for details.

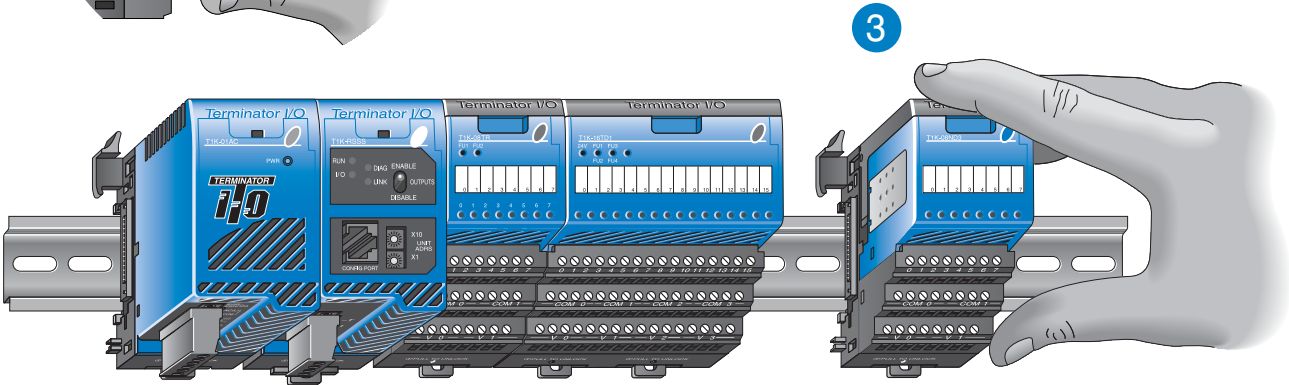
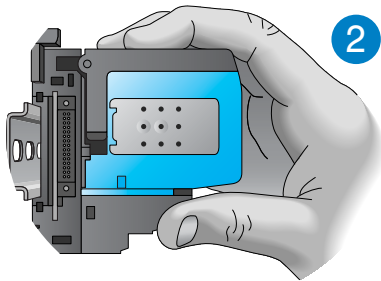

## Removing I/O modules is a snap

Grip the locking handle, as shown, and pull gently to eject the I/O module from its base. The module will slide out for easy replacement. This procedure does not apply to network interface modules or power supplies, which have integral bases.

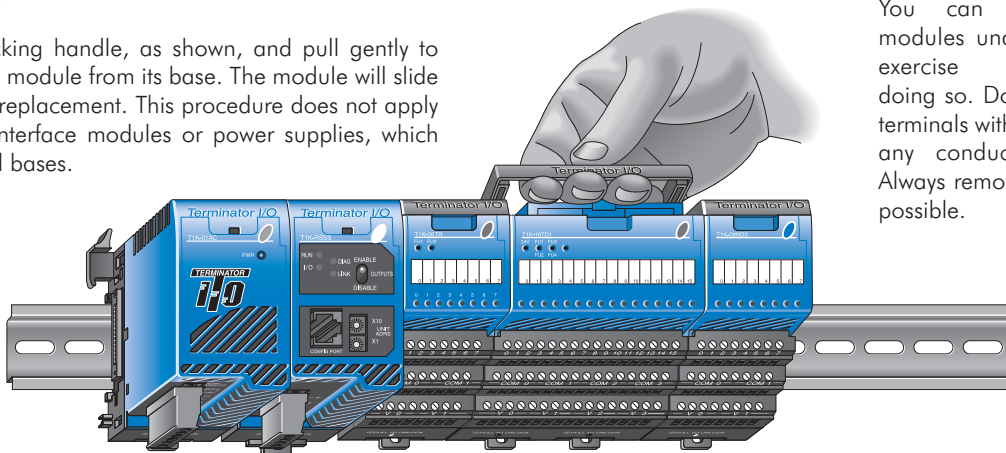

## Hot-swappable I/O modules

You can remove I/O modules under power, but exercise caution while doing so. Do not touch the terminals with your hands or any conductive material. Always remove power when possible.

# Power Supplies and Power Requirements

## Power supplies

The Terminator I/O product line offers two power supply options: AC or DC. The power supplies are always positioned to the left of the modules to which they supply power. Consult the system configuration examples and the power budgeting example for more information on positioning power supplies.

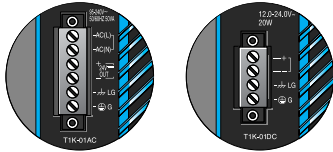

## Power supply specifications

Power Supply Specifications		T1K-01AC ↕↔↔↔↔	T1K-01DC ↕↔↔↔↔
<b>Input Voltage Range</b>		110/220 VAC	12/24 VDC
<b>Input Frequency</b>		50/60 Hz	N/A
<b>Maximum Power</b>		50 VA	30 W
<b>Max. Inrush Current</b>		20 A	10 A
<b>Insulation Resistance</b>		> 10 MΩ @ 500 VDC	
<b>Voltage Withstand</b>		1 min. @ 1500 VAC between primary, secondary and field ground	
<b>5VDC PWR</b>	<b>Voltage</b>	5.25 VDC	5.25 VDC
	<b>Current Rating</b>	2000 mA max (see current option note below)	2000 mA max
	<b>Ripple</b>	5% max.	5% max.
<b>24VDC PWR</b>	<b>Voltage</b>	24 VDC	N/A
	<b>Current Rating</b>	300 mA max. (see current option note below)	N/A
	<b>Ripple</b>	10% max.	N/A
<b>Fuse</b>		1 (primary), not replaceable	
Note: 500 mA @ 24 VDC can be achieved by lowering the 5VDC from 2000 mA to 1500 mA.			

## Power requirements

Module	5VDC	24VDC	Module	5VDC	24VDC	Module	5VDC	24VDC
<b>Interface Modules</b>			<b>DC Output Modules</b>			<b>Analog Input Modules</b>		
T1H-EBC	350	0	T1H-08TDS	200	0	T1F-08AD-1	75	50*
T1H-EBC100	300	0	T1K-08TD1	100	200*	T1F-08AD-2	75	50*
T1H-PBC	530	0	T1K-16TD1	200	400*	T1F-16AD-1	75	50*
T1K-DEVNETS	250	45	T1K-08TD2-1	200	0	T1F-16AD-2	75	50*
T1K-RSSS	250	0	T1K-16TD2-1	200	0	T1F-14THM	60	70*
T1K-MOVBUS	300	0	<b>AC Output Modules</b>			T1F-16RTD	150	0
<b>DC Input Modules</b>			T1K-08TA	250	0	<b>Analog Output Modules</b>		
T1K-08ND3	35	0	T1K-16TA	450	0	T1F-08DA-1	75	75*
T1K-16ND3	70	0	T1K-08TAS	300	0	T1F-08DA-2	75	75*
<b>AC Input Modules</b>			<b>Relay Output Modules</b>			T1F-16DA-1	75	150*
T1K-08NA-1	35	0	T1K-08TR	350	0	T1F-16DA-2	75	150*
T1K-16NA-1	70	0	T1K-16TR	700	0	<b>Combination Analog Modules</b>		
			T1K-08TRS	400	0	T1F-8AD4DA-1	75	60*
			<b>Specialty Modules</b>			T1F-8AD4DA-2	75	70*
			T1H-CTRIO	400	0	* Use either internal or external source for 24VDC		
			* Use either internal or external source for 24VDC					

## Calculating the power budget

To calculate the power budget, read the available power (current rating) from the Power Supply Specifications table and subtract the power consumed by each module to the right of the power supply. Do not include modules to the right of an additional power supply.

## Adding additional power supplies

Each power supply furnishes power only to the network interface and I/O modules to its right. Inserting a second power supply closes the power loop for the power supply to the left, while also powering the modules to its right. Perform a power budget calculation for each power supply in the system.

Power Budget Example		
Module	5VDC	24VDC
T1K-01AC	+2000 mA	+300 mA
T1H-EBC	-350 mA	-0 mA
T1K-16ND3	-70 mA	-0 mA
T1K-16TD2	-200 mA	-0 mA
T1F-08AD-1	-75 mA	-50 mA
Remaining	+1305 mA	+250 mA

Accessories available for Terminator I/O are listed in the Terminator Field I/O section of the Price List

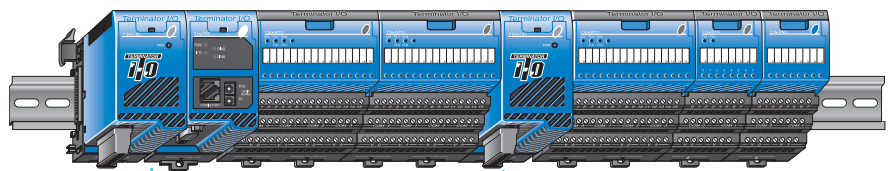

This power supply powers the network interface module and the next two I/O modules

This power supply powers these three I/O modules

# Expansion I/O Configurations

## Expansion cables

T1K-10CBL <--->

T1K-10CBL-1\* <--->

**Right side to left side expansion cable**

The T1K-10CBL(-1) connects the right side of an I/O base to the left side of the next I/O base. A maximum of two T1K-10CBL(-1) cables can be used per expansion system.

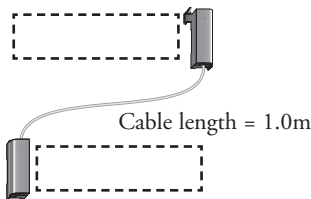

T1K-05CBL-LL <--->

T1K-05CBL-LL-1\* <--->

**Left side to left side expansion cable**

The T1K-05CBL-LL(-1) connects the left side of an I/O base to the left side of the next I/O base. Only one T1K-05CBL-LL(-1) cable can be used per expansion system and must be used with a T1K-05CBL-RR(-1) cable. **This cable cannot be connected to the left side of the network interface base.**

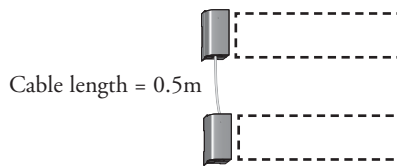

T1K-05CBL-RR <--->

T1K-05CBL-RR-1\* <--->

**Right side to right side expansion cable**

The T1K-05CBL-RR(-1) connects the right side of an I/O base to the right side of the next I/O base. A maximum of one T1K-05CBL-RR(-1) cable can be used per expansion system. **Note: When this cable is used, the expansion I/O assignments are from right to left (reversed).**

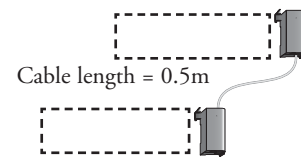

**\*Note:** The (-1) versions of the expansion cables pass 24 VDC through on an isolated wire. (All cables pass the 5 VDC base power.) Any local expansion DC input module configured for "internal power" (current sourcing) must either have a power supply preceding it on the same base or, have a (-1) version cable pass 24 VDC from a power supply on the preceding base.

## Using two T1K-10CBL expansion cables

In the system below, power supplies can be used anywhere.

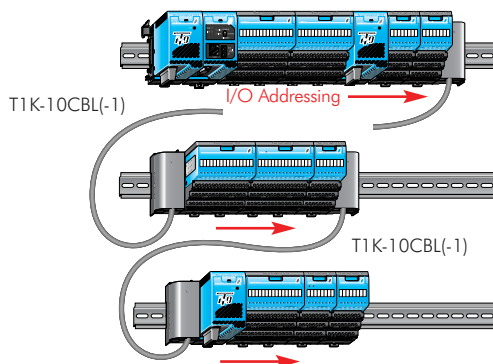

## Using T1K-10CBL expansion cable and T1K-05CBL-RR expansion cable

Power supplies can be used anywhere in the first two bases, but not in the last expansion base.

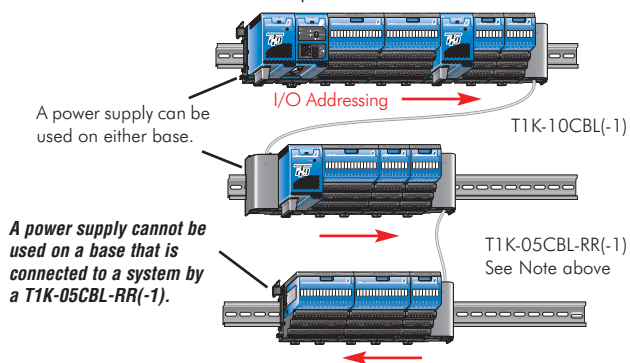

## Using T1K-05CBL-RR expansion cable and T1K-05CBL-LL expansion cable

Power supplies can be used anywhere in the first and third bases, but not in the second base.

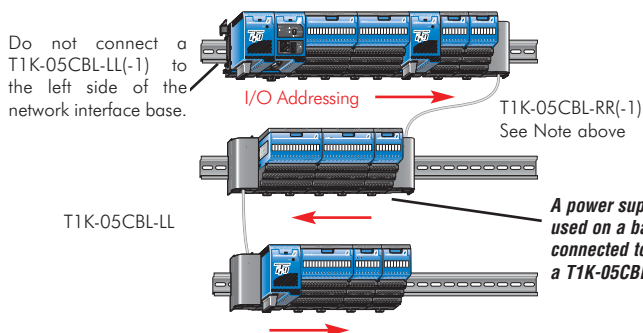

## Using T1K-05CBL-RR expansion cable

Power supplies can be used anywhere in the first base, but not in the second base.

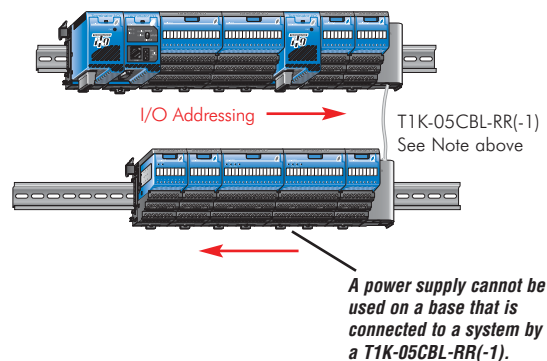

# Field Device Wiring and Power Options

## Terminal base specifications

Terminator I/O terminal bases are available in screw clamp and spring clamp versions for both half-size and full-size modules. Hot stamp silkscreen labeling is used for numbering I/O points, commons, and all power terminals.

Terminal Base Specifications		
<b>Terminal Type</b>	Screw type	Spring clamp
<b>Recommended Torque</b>	1.77-3.54 lb-in (0.2 - 0.4 Nm)	n/a
<b>Wire Gauge</b>	Solid: 25-12 AWG Stranded: 26-12 AWG	Solid: 25-14 AWG Stranded: 26-14 AWG

## Field device wiring options

Power your DC input devices from the integrated 24 VDC power supply bus. T1K-08ND3 and T1K-16ND3 DC input modules include jumpers for selecting the internal 24 VDC power supply available for 2- and 3-wire field devices. Clearly labeled triple stack terminals make it easy to wire 2- and 3-wire devices ensuring clean wiring with only one wire per termination.

External user supplied 24 VDC power, or auxiliary 24 VDC terminals from T1K-01AC, can be easily applied directly to one end of the terminal rows and jumpered across each base in the system.

This is a convenient solution for powering analog I/O and discrete DC output devices whose modules do not have direct access to the internal bussed 24 VDC. If current consumption increases, simply add additional T1K-01AC power supplies into the system.

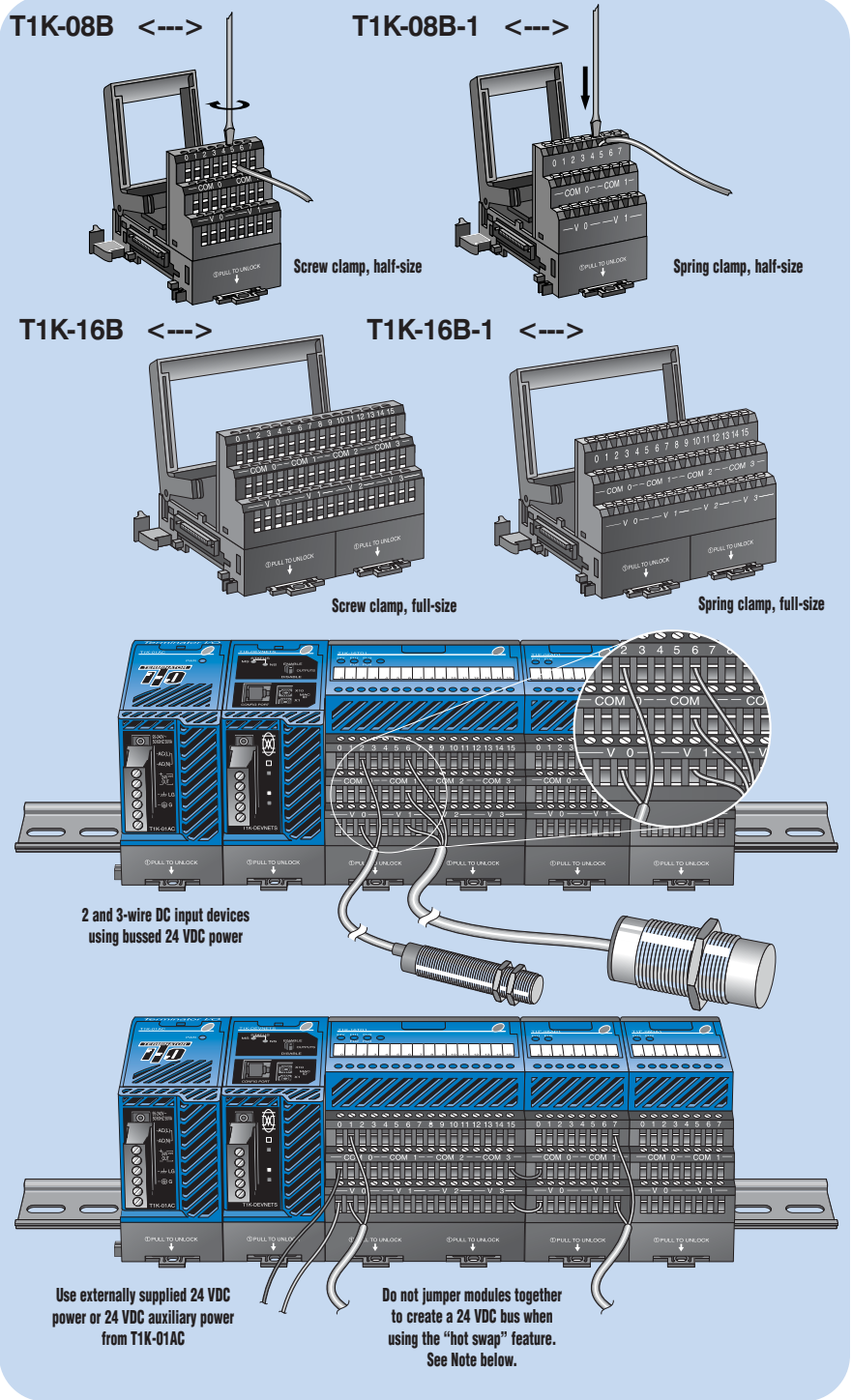

## Hot-swap feature

The hot-swap feature allows Terminator I/O modules to be replaced while system power is on. Be careful not to touch the terminals with your hands or other conductive material to avoid the risk of personal injury or equipment damage. Always remove power if it is equally convenient to do so.

**Note:** Before hot-swapping analog or DC output modules in a Terminator I/O system, make sure that each of the analog and DC output module's 24 VDC and 0 VDC base terminals are wired directly to the external power supply individually. If the external 24 VDC and 0 VDC is jumpered from base to base in a daisy

chain fashion, and an analog or DC output module is removed from its base, the risk of disconnecting the external 24 VDC and 0 VDC to the subsequent I/O modules exists.